



GRIFERIA

Claus y Bath, S.L., empresa creada en Valencia en 2011 presenta su nuevo catálogo.

Lanzamos al mercado nuevas griferías de cocina y baño, complementos y accesorios, así como una completísima gama de conjuntos para la ducha.

Todos nuestros productos son fabricados en latón y acero SS304, y las monturas y cartuchos que utilizamos cuentan con las correspondientes certificaciones.

Tenemos diseño, variedad de acabados, calidad y un magnífico precio. Todo unido a un excelente servicio hacen de nuestro catálogo una de las mejores opciones del mercado.

Esperamos sea de su agrado.



INDICE

■ Grifería de BAÑO _____	05
■ Conjuntos de DUCHA _____	157
■ Conjuntos EMPOTRADOS _____	197
■ Grifería de COCINA _____	227
■ Grifería ESPECIAL _____	281
■ COMPLEMENTOS _____	301
■ REPUESTOS _____	346

Grifería de **BAÑO**

■ Serie BARI	06 / 13
■ Serie BARI GRIS METAL	14 / 21
■ Serie TURIN	22 / 31
■ Serie TURIN NEGRO	32 / 41
■ Serie TURIN ORO	42 / 51
■ Serie TURIN ROSA	52 / 61
■ Serie TURIN GRIS METAL	62 / 71
■ Serie KU	72 / 81
■ Serie KU NEGRO	82 / 89
■ Serie CIES	90 / 93
■ Serie VARTA	94 / 97
■ Serie YDRA	98 / 101
■ Serie BONN	102 / 111
■ Serie KOBÁ	112 / 117
■ Serie KOBÁ NEGRO	118 / 123
■ Serie KOBÁ ORO	124 / 127
■ Serie JADE	128 / 135
■ Serie JADE NEGRO	136 / 143
■ Serie ZURICH	144 / 147
■ Serie ALFA	148 / 149
■ Serie CLASSIC	150 / 153
■ Serie CLASSIC BRONCE	154 / 155



Serie BARI



121641

Monomando lavabo / Basin mixer

Acabado cromo
Cartucho 26 mm

PVP: 76,00 €

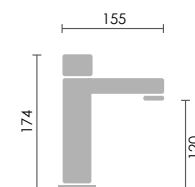

121646

Monomando lavabo alto / Basin mixer

Acabado cromo
Cartucho 26 mm

PVP: 120,00 €

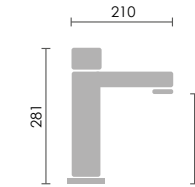

121642

Monomando bidé / Bidet mixer

Acabado cromo
Cartucho 26 mm

PVP: 76,00 €

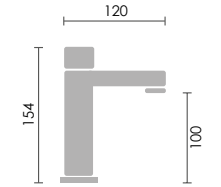

121643

Monomando baño ducha / Bathtub mixer

Acabado cromo
Cartucho 35 mm

PVP: 135,00 €

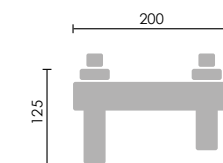

121644

Monomando ducha / Shower mixer

Acabado cromo
Cartucho 35 mm

PVP: 95,00 €

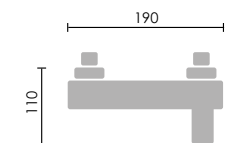

Incluido el kit de ducha. Flexo, mango de ducha y soporte.



Serie **BARI**

clausy bath

Criferia de
BANO

121647

Monomando lavabo empotrado / In wall basin mixer

Caja registrable
Acabado cromo
Cartucho 35 mm.

PVP: 105,00 €

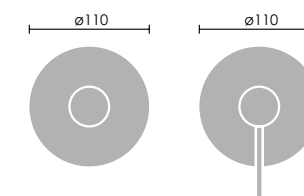

Serie **BARI**

121650

Conjunto Monomando

Rociador antical acero SS304 de 250 mm
 Monomando empotrado de 2 vías
 Caja registrable
 Brazo de ducha de 1/2x37 cm
 Codo de ducha c/ soporte integrado
 Flexo reforzado cromado 1,50-2,0 m.
 Ducha de 3 posiciones
 Acabado: Cromo

PVP: 210,00 €

121648

Grifo monomando empotrado

Acabado cromo
 Incluye caja registrable
 No incluye flexo ni mango de ducha

PVP: 115,00 €



No incluye flexo ni mango de ducha





Serie **BARI**

122018

Conjunto Monomando cartucho 35 mm

Barra extensible (De 870 a 1350 mm)
Rociador antical acero 250 mm
Flexo cónico reforzado de 1,5-2,0 m
Ducha modelo 300 - 3 posiciones
Acabado cromo

PVP: 195,00 €

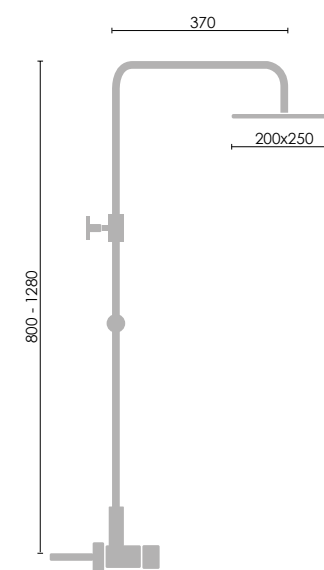

Serie **BARI** Gris metal PVD



121641GM

Monomando lavabo / Basin mixer

Acabado gris metal
Cartucho 26 mm

PVP: 88,00 €

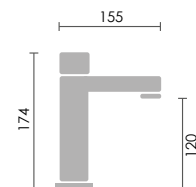

121646GM

Monomando lavabo alto / Basin mixer

Acabado gris metal
Cartucho 26 mm.

PVP: 140,00 €

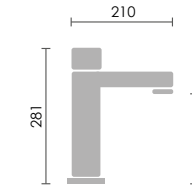

121642GM

Monomando bidé / Bidet mixer

Acabado gris metal
Cartucho 26 mm.

PVP: 88,00 €

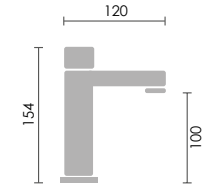

121643GM

Monomando baño ducha / Bathtub mixer

Acabado gris metal
Cartucho 35 mm.

PVP: 156,00 €

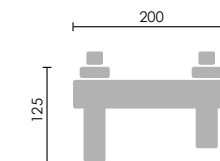

121644GM

Monomando ducha / Shower mixer

Acabado gris metal
Cartucho 35 mm.

PVP: 112,00 €

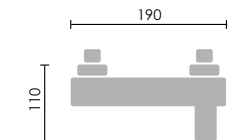

Incluido el kit de ducha. Flexo, mango de ducha y soporte.



Serie **BARI** Gris metal

121647GM

Monomando lavabo empotrado / In wall basin mixer

Acabado gris metal
Cartucho 35 mm.

PVP: 130,00 €

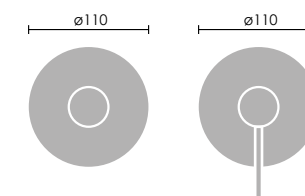

Serie **BARI** Gris metal

121650GM

Conjunto Monomando

Rociador antical acero SS304 de 250 mm
 Monomando empotrado de 2 vías
 Caja registrable
 Brazo de ducha de 1/2x37 cm
 Codo de ducha c/ soporte integrado
 Flexo reforzado PVC gris de 1,70 m.
 Ducha de 3 posiciones
 Acabado: Gris metal

PVP: 255,00 €

121648GM

Grifo monomando empotrado

Acabado gris metal
 Incluye caja registrable
 No incluye flexo ni mango de ducha

PVP: 135,00 €



No incluye flexo ni mango de ducha





Serie **BARI** Gris metal

122018GM

Conjunto Monomando cartucho 35 mm

Barra extensible (De 870 a 1350 mm)
Rociador antical acero 250 mm
Flexo cónico de PVC 1,70 gris metal.
Ducha modelo 350 - 3 posiciones
Acabado gris metal

PVP: 265,00 €

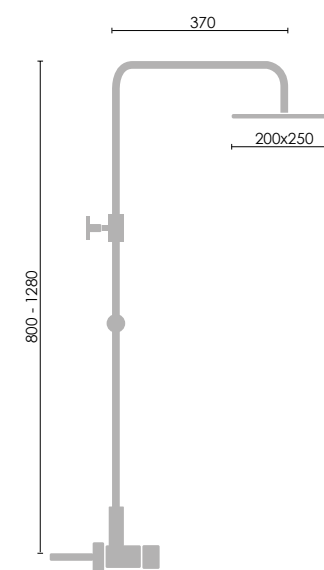

Serie TURÍN



121141

Monomando lavabo / Basin mixer

Acabado cromo
Cartucho 25 mm.

PVP: 62,00 €

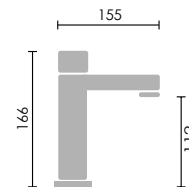

121146

Monomando lavabo alto / Basin mixer

Acabado cromo
Cartucho 25 mm.

PVP: 83,00 €

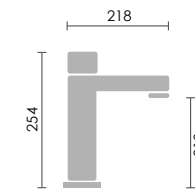

121142

Monomando bidé / Bidet mixer

Acabado cromo
Cartucho 25 mm.

PVP: 62,00 €

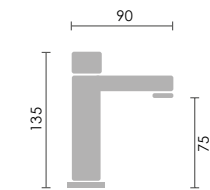

121143

Monomando baño ducha / Bathtub mixer

Acabado cromo
Cartucho 35 mm.

PVP: 123,00 €

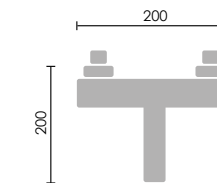

121144

Monomando ducha / Shower mixer

Acabado cromo
Cartucho 35 mm.

PVP: 95,00 €

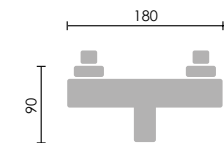

Incluido el kit de ducha. Flexo, mango de ducha y soporte.

Serie **TURÍN**



121145

Monomando lavabo empotrado / In wall basin mixer

Acabado cromo
Cartucho 35 mm.

PVP: 87,00 €



121108

**Conjunto sustitución bidé 2 aguas /
Supply bidet**

Flexo cromado 1,20 antitorsión
Acabado cromo
Cartucho 35 mm.

PVP: 95,00 €



Serie **TURÍN**

121045

Conjunto monomando empotrado

Rociador antical acero SS304 de 250 mm
 Monomando empotrado de 2 vías
 Caja registrable
 Brazo de ducha de 1/2x37 cm
 Salida para flexo c/ soporte integrado
 Flexo reforzado cromado 1,50-2,0 m.
 Ducha de 3 posiciones
 Acabado: Cromo

PVP: 225,00 €

121148

Grifo monomando empotrado

Incluye caja registrable
 No incluye flexo ni mango de ducha

PVP: 155,00 €

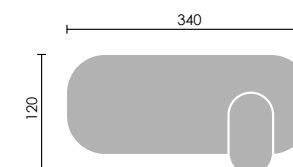

Serie **TURÍN**

121650

Conjunto monomando empotrado

Rociador antical acero SS304 de 250 mm
 Monomando empotrado de 2 vías
 Caja registrable
 Brazo de ducha de 1/2x37 cm
 Codo de ducha c/ soporte integrado
 Flexo reforzado PVC gris de 1,70 m.
 Ducha de 3 posiciones
 Acabado: Cromo

PVP: 195,00 €

121649

Grifo monomando empotrado

Incluye caja registrable
 No incluye flexo ni mango de ducha

PVP: 105,00 €



No incluye flexo ni mango de ducha



Serie **TURÍN**

122012

Conjunto monomando

Cartucho 35 mm
 Barra extensible (de 870 a 1350 mm)
 Rociador antical acero 250 mm
 Flexo reforzado 1,5-2,0 m
 Ducha de 3 posiciones modelo 300
 Acabado cromo

PVP: 192,00 €

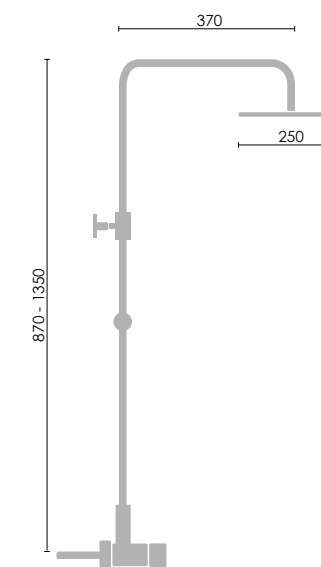

Serie **TURÍN** Negro

PVD



121141NG

Monomando lavabo / Basin mixer

Acabado negro mate

Cartucho 25 mm.

PVP: 74,00 €

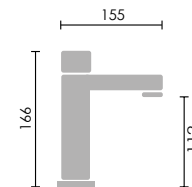

121146NG

Monomando lavabo alto / Basin mixer

Acabado negro mate

Cartucho 25 mm.

PVP: 95,00 €

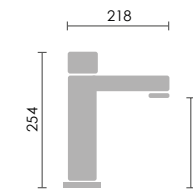

121142NG

Monomando bidé / Bidet mixer

Acabado negro mate

Cartucho 25 mm.

PVP: 74,00 €

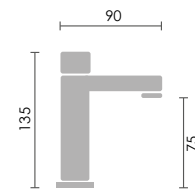

121143NG

Monomando baño ducha / Bathtub mixer

Acabado negro mate

Cartucho 35 mm.

PVP: 144,00 €

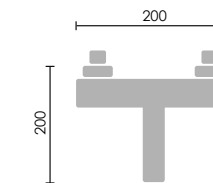

121144NG Monomando ducha / Shower mixer

Acabado negro mate

Cartucho 35 mm.

PVP: 115,00 €

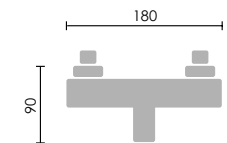

Incluido el kit de ducha. Flexo, mango de ducha y soporte.

Serie **TURÍN** Negro



121145NG

Monomando lavabo empotrado / In wall basin mixer

Acabado negro
Cartucho 35 mm.

PVP: 98,00 €



121108 NG

**Conjunto sustitución bidé 2 aguas /
Supply bidet**

Flexo 1,20 PVC negro
Acabado negro mate
Cartucho 35 mm.

PVP: 118,00 €

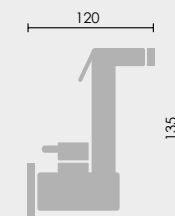

Serie **TURÍN** Negro

121045NG

Conjunto monomando empotrado

Rociador antical acero SS304 de 250 mm
 Monomando empotrado de 2 vías
 Caja registrable
 Brazo de ducha de 1/2x37 cm
 Salida para flexo c/ soporte integrado
 Flexo 1,7 PVC NEGRO
 Ducha de 3 posiciones
 Acabado: Negro mate

PVP: 330,00 €

121148NG

Grifo monomando empotrado

Incluye caja registrable
 No incluye flexo ni mango de ducha

PVP: 186,00 €

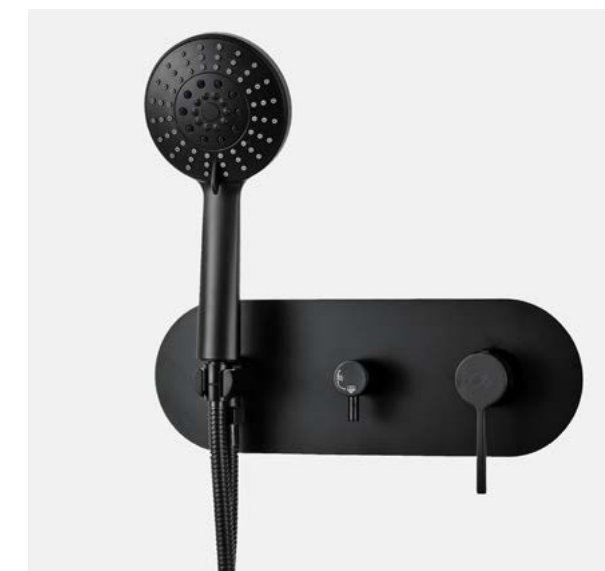
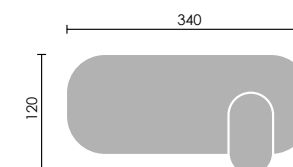

Serie **TURÍN** Negro

121650NG

Conjunto monomando empotrado

Rociador antical acero SS304 de 250 mm
 Monomando empotrado de 2 vías
 Caja registrable
 Brazo de ducha de 1/2x37 cm
 Codo de ducha c/ soporte integrado
 Flexo 1,7 PVC NEGRO
 Ducha de 3 posiciones
 Acabado: Negro

PVP: 245,00 €

121649NG

Grifo monomando empotrado

Incluye caja registrable
 No incluye flexo ni mango de ducha

PVP: 125,00 €

No incluye flexo ni mango de ducha



Serie **TURÍN** Negro

122012NG

Conjunto monomando

Cartucho 35 mm
 Barra extensible (de 870 a 1350 mm)
 Rociador antical acero 250 mm
 Flexo de PVC 1,50 negro mate
 Ducha modelo 320 - 5 posiciones
 Acabado negro mate

PVP: 265,00 €

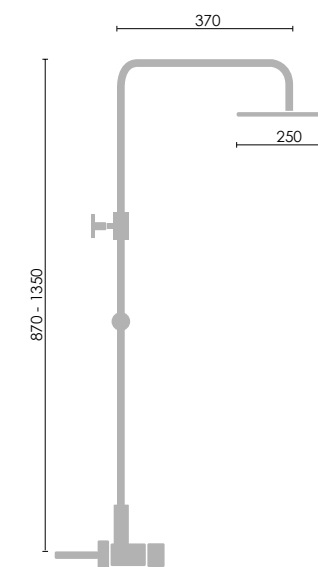

Serie **TURÍN** Oro

PVD



121146OR

Monomando lavabo alto / Basin mixer

Acabado oro cepillado
Cartucho 35 mm.

PVP: 95,00 €

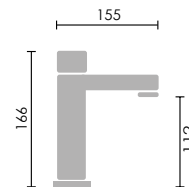

121141OR

Monomando lavabo / Basin mixer

Acabado oro cepillado
Cartucho 25 mm.

PVP: 74,00 €

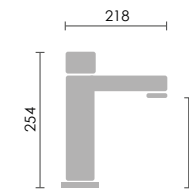

121142OR

Monomando bidé / Bidet mixer

Acabado oro cepillado
Cartucho 25 mm.

PVP: 74,00 €

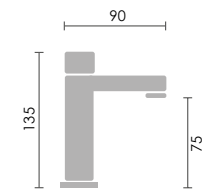

121143OR

Monomando baño ducha / Bathtub mixer

Acabado oro cepillado
Cartucho 35 mm.

PVP: 144,00 €

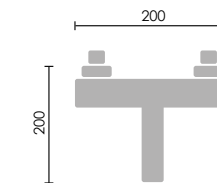

121144OR

Monomando ducha / Shower mixer

Acabado oro cepillado
Cartucho 35 mm.

PVP: 115,00 €

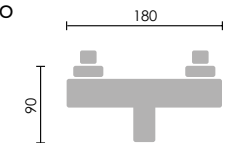

Incluido el kit de ducha. Flexo, mango de ducha y soporte.

Serie **TURÍN** Oro



121145OR

Monomando lavabo empotrado / In wall basin mixer

Acabado oro cepillado
Cartucho 35 mm.

PVP: 98,00 €

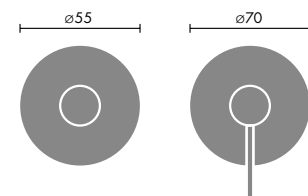

121108OR

**Conjunto sustitución bidé 2 aguas /
Supply bidet**

Flexo PVC 1,20 oro cepillado
Acabado oro cepillado
Cartucho 35 mm.

PVP: 135,00 €

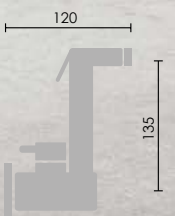

Serie **TURÍN** Oro

121045OR

Conjunto monomando empotrado

Rociador antical acero SS304 de 250 mm
 Monomando empotrado de 2 vías
 Caja registrable
 Brazo de ducha de 1/2x37 cm
 Salida para flexo c/ soporte integrado
 Flexo de PVC 1,50 m.
 Ducha de 3 posiciones
 Acabado: Oro cepillado

PVP: 330,00 €

121148OR

Grifo monomando empotrado

Incluye caja registrable
 No incluye flexo ni mango de ducha

PVP: 186,00 €

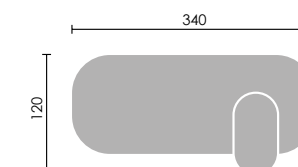

Serie **TURÍN** Oro

121650OR

Conjunto Monomando

Rociador antical acero SS304 de 250 mm
 Monomando empotrado de 2 vías
 Caja registrable
 Brazo de ducha de 1/2x37 cm
 Codo de ducha c/ soporte integrado
 Flexo PVC Oro de 1,70 m.
 Ducha de 3 posiciones
 Acabado: Oro Cepillado

PVP: 245,00 €

121649OR

Grifo monomando empotrado

Incluye caja registrable
 No incluye flexo ni mango de ducha

PVP: 125,00 €



No incluye flexo ni mango de ducha



Serie **TURÍN** Oro

122012OR

Monomando cartucho 35 mm

Barra extensible (de 870 a 1350 mm)
Rociador antical acero 250 mm
Flexo de PVC 1,50 oro cepillado
Ducha modelo 330 - 5 posiciones
Acabado oro cepillado

PVP: 265,00 €

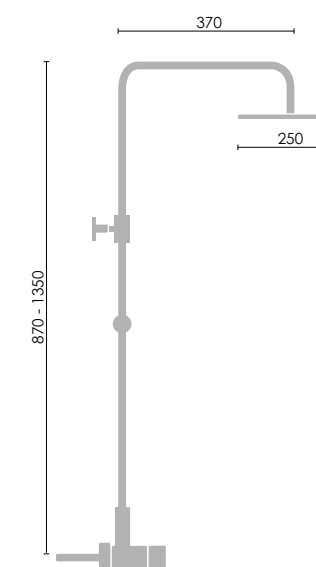

Serie **TURÍN** Rosa

PVD

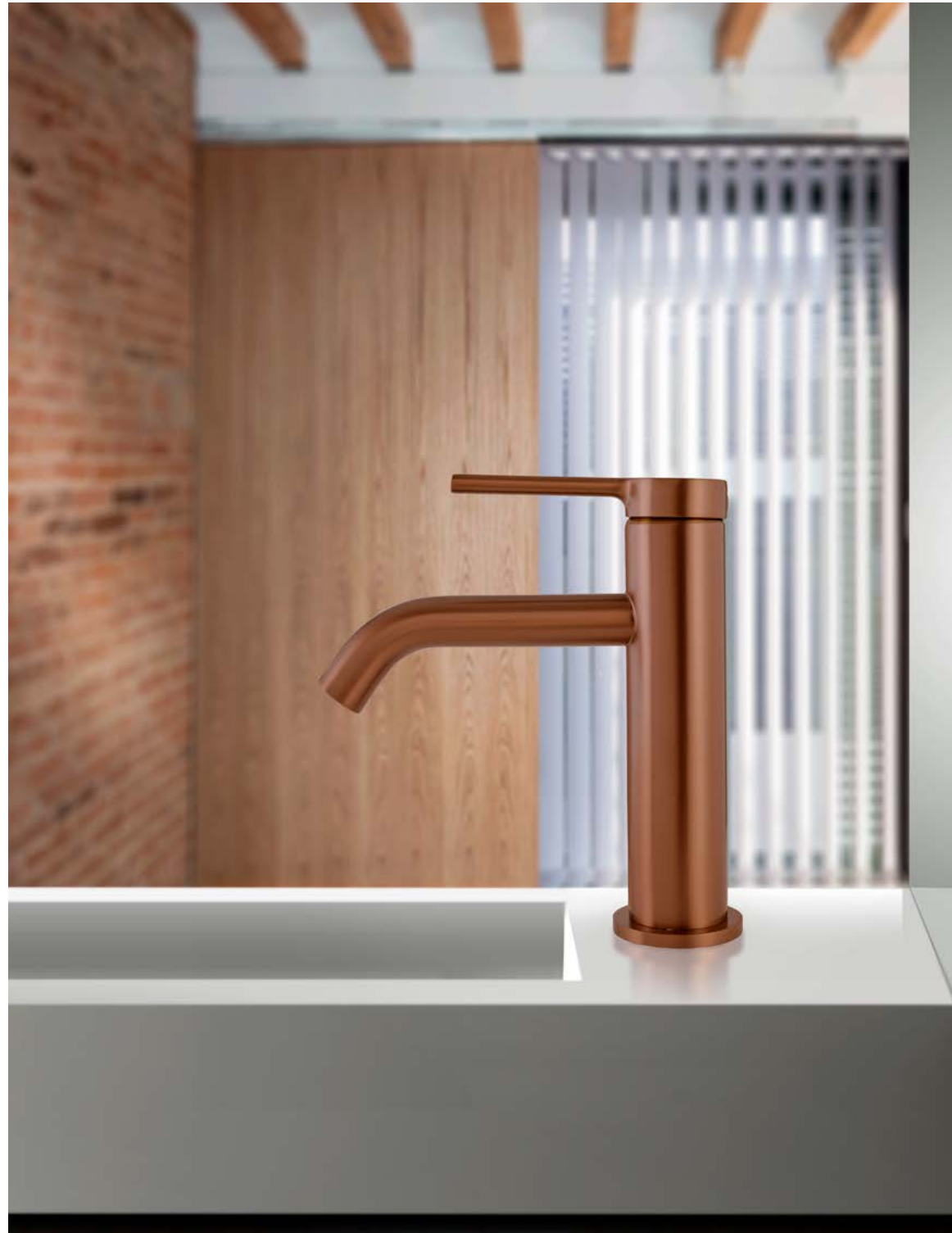

121141RC

Monomando lavabo / Basin mixer

Acabado rosa cepillado
Cartucho 25 mm.

PVP: 74,00 €

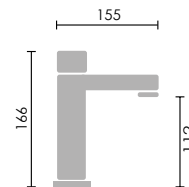

121146RC

Monomando lavabo alto / Basin mixer

Acabado rosa cepillado
Cartucho 25 mm.

PVP: 95,00 €

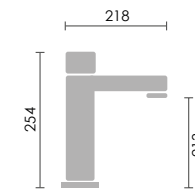

121142RC

Monomando bidé / Bidet mixer

Acabado rosa cepillado
Cartucho 25 mm.

PVP: 74,00 €

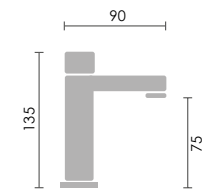

121143RC

Monomando baño ducha / Bathtub mixer

Acabado rosa cepillado
Cartucho 35 mm.

PVP: 144,00 €

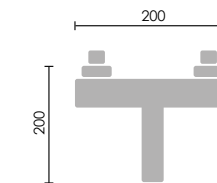

121144RC

Monomando ducha / Shower mixer

Acabado rosa cepillado
Cartucho 35 mm.

PVP: 115,00 €

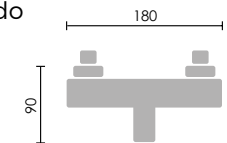

Incluido el kit de ducha. Flexo, mango de ducha y soporte.

Serie **TURÍN** Rosa



121145RC

Monomando lavabo empotrado / In wall basin mixer

Acabado rosa cepillado
Caja registrable
Cartucho 35 mm.

PVP: 98,00 €

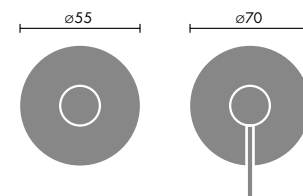

121108RC

**Conjunto sustitución bidé 2 aguas /
Supply bidet**

Flexo 1,20 PVC ROSA
Acabado Rosa
Cartucho 35 mm.

PVP: 135,00 €

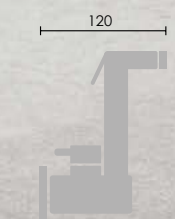

Serie **TURÍN** Rosa

121045RC

Conjunto Monomando

Rociador antical acero SS304 de 250 mm
 Monomando empotrado de 2 vías
 Caja registrable
 Brazo de ducha de 1/2x37 cm
 Salida para flexo c/ soporte integrado
 Flexo 1.7 PVC ROSA
 Ducha de 3 posiciones
 Acabado: Rosa cepillado

PVP: 330,00 €

121148RC

Grifo monomando empotrado

Incluye caja registrable
 No incluye flexo ni mango de ducha

PVP: 186,00 €

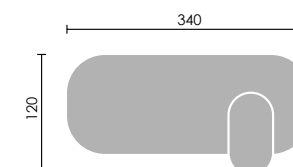

Serie **TURÍN** Rosa

121650RC

Conjunto monomando empotrado

Rociador antical acero SS304 de 250 mm
 Monomando empotrado de 2 vías
 Caja registrable
 Brazo de ducha de 1/2x37 cm
 Codo de ducha c/ soporte integrado
 Flexo 1,7 PVC ROSA
 Ducha de 3 posiciones
 Acabado: Rosa Cepillado

PVP: 245,00 €

121649RC

Grifo monomando empotrado

Incluye caja registrable
 No incluye flexo ni mango de ducha

PVP: 125,00 €



No incluye flexo ni mango de ducha



Serie **TURÍN** Rosa

122012RC

Conjunto Monomando cartucho 35 mm

Barra extensible (de 870 a 1350 mm)
 Rociador antical acero 250 mm
 Flexo 1,7 PVC ROSA
 Ducha modelo 360 - 3 posición
 Acabado rosa cepillado

PVP: 265,00 €

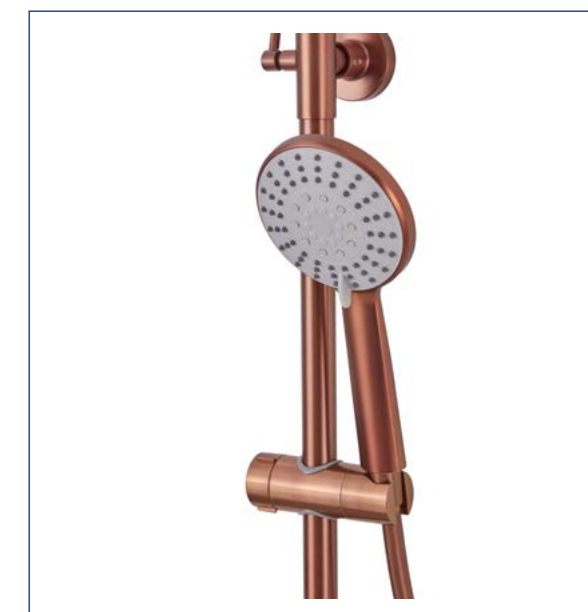
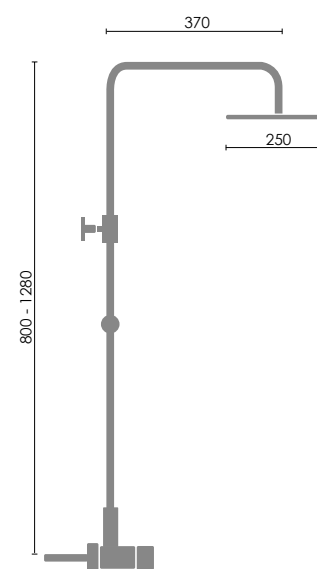

Serie **TURÍN** Gris metal PVD



121146GM

Monomando lavabo alto / Basin mixer

Acabado gris metal
Cartucho 25 mm

PVP: 95,00 €

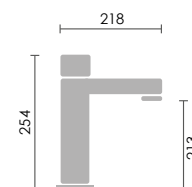

121141GM

Monomando lavabo / Basin mixer

Acabado gris metal
Cartucho 25 mm

PVP: 74,00 €

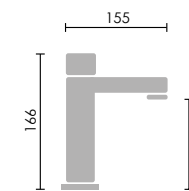

121142GM

Monomando bidé / Bidet mixer

Acabado gris metal
Cartucho 25 mm

PVP: 74,00 €

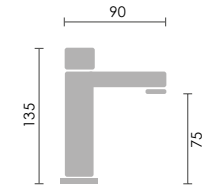

121143GM

Monomando baño ducha / Bathtub mixer

Acabado gris metal
Cartucho 35 mm

PVP: 144,00€

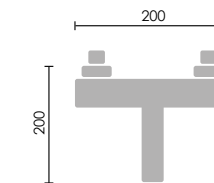

121144GM

Monomando ducha / Shower mixer

Acabado gris metal
Cartucho 35 mm

PVP: 115,00€

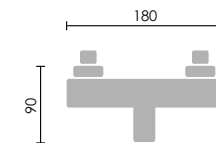

Incluido el kit de ducha. Flexo, mango de ducha y soporte.

Serie **TURÍN** Gris metal



121145GM

Monomando lavabo empotrado / In wall basin mixer

Acabado gris metal
Cartucho 35 mm.

PVP: 98,00 €

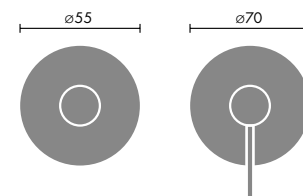

121108GM

Conjunto sustitución bidé 2 aguas / Supply bidet

Flexo 1,7 PVC GRIS
Acabado gris metal
Cartucho 35 mm.

PVP: 135,00 €

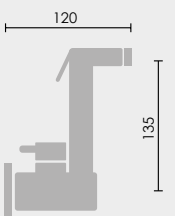

Serie **TURÍN** Gris metal



121045GM

Conjunto Monomando

Rociador antical acero SS304 de 250 mm
 Monomando empotrado de 2 vías
 Caja registrable
 Brazo de ducha de 1/2x37 cm
 Codo de ducha c/ soporte integrado
 Flexo reforzado PVC gris de 1,70 m.
 Ducha de 3 posiciones
 Acabado: Gris metal

PVP: 330,00 €

121148GM

Grifo monomando empotrado

Incluye caja registrable
 No incluye flexo ni mango de ducha

PVP: 186,00 €

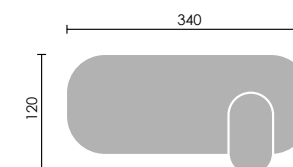

Serie **TURÍN** Gris metal

121650GM

Conjunto monomando empotrado

Rociador antical acero SS304 de 250 mm
 Monomando empotrado de 2 vías
 Caja registrable
 Brazo de ducha de 1/2x37 cm
 Codo de ducha c/ soporte integrado
 Flexo PVC Gris de 1,70 m.
 Ducha de 3 posiciones
 Acabado: Gris Metal

PVP: 245,00 €

121649GM

Grifo monomando empotrado

Incluye caja registrable
 No incluye flexo ni mango de ducha

PVP: 125,00 €

No incluye flexo ni mango de ducha



Serie **TURÍN** Gris metal



122012GM

Conjunto Monomando cartucho 35 mm

Barra extensible (De 870 a 1350 mm)
 Rociador antical acero 250 mm
 Flexo cónico de PVC 1,70 gris metal.
 Ducha modelo 350 - 3 posiciones
 Acabado gris metal

PVP: 265,00 €

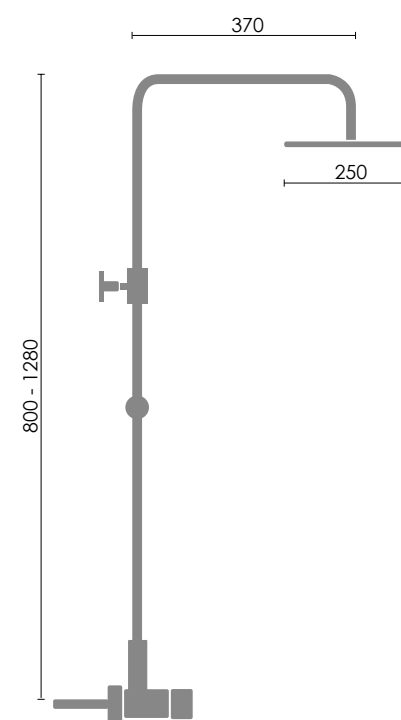

Serie **KU**



121006

Monomando lavabo alto / Basin mixer

Acabado cromo
Cartucho 25 mm.

PVP: 118,00 €

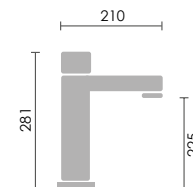

121001

Monomando lavabo / Basin mixer

Acabado cromo
Cartucho 25 mm.

PVP: 78,00 €

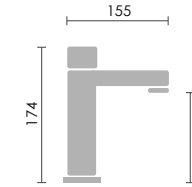

121002

Monomando bidé / Bidet mixer

Acabado cromo
Cartucho 25 mm.

PVP: 78,00 €

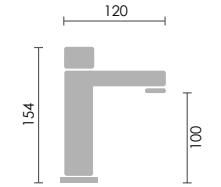

121003

Monomando baño ducha / Bathtub mixer

Acabado cromo
Cartucho 35 mm.

PVP: 145,00 €

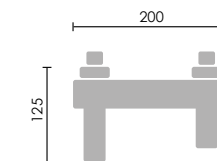

121004

Monomando ducha / Shower mixer

Acabado cromo
Cartucho 35 mm.

PVP: 111,00 €

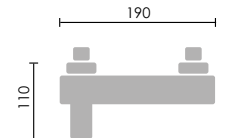

Incluido el kit de ducha. Flexo, mango de ducha y soporte.

ACS WRAS KTW
APPROVED PRODUCT
Cartuchos certificados.

Serie **KU**



121009

Monomando lavabo empotrado / In wall basin mixer

Acabado cromo
Cartucho 35 mm.

PVP: 125,00 €

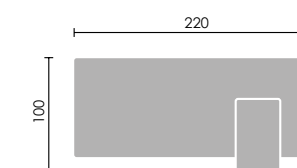

Cuerpo en caja empotrable
Profundidad: 63 mm



Serie **KU**

clausy bath

Criferia de **BANO**

122026

Monomando cartucho 35 mm

Barra extensible (de 800 a 1280 mm)
Rociador antical acero 200x250 mm
Flexo reforzado de 1,5-2,0
Ducha modelo 150 - 1 posición
Acabado cromo

PVP: 260,00 €

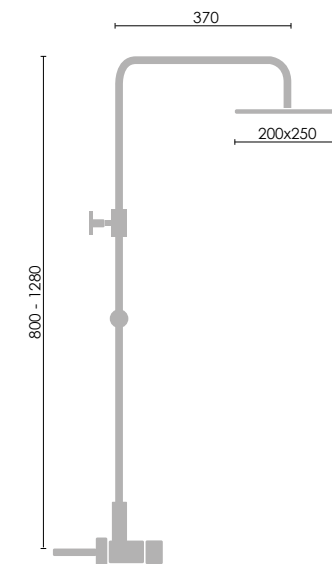

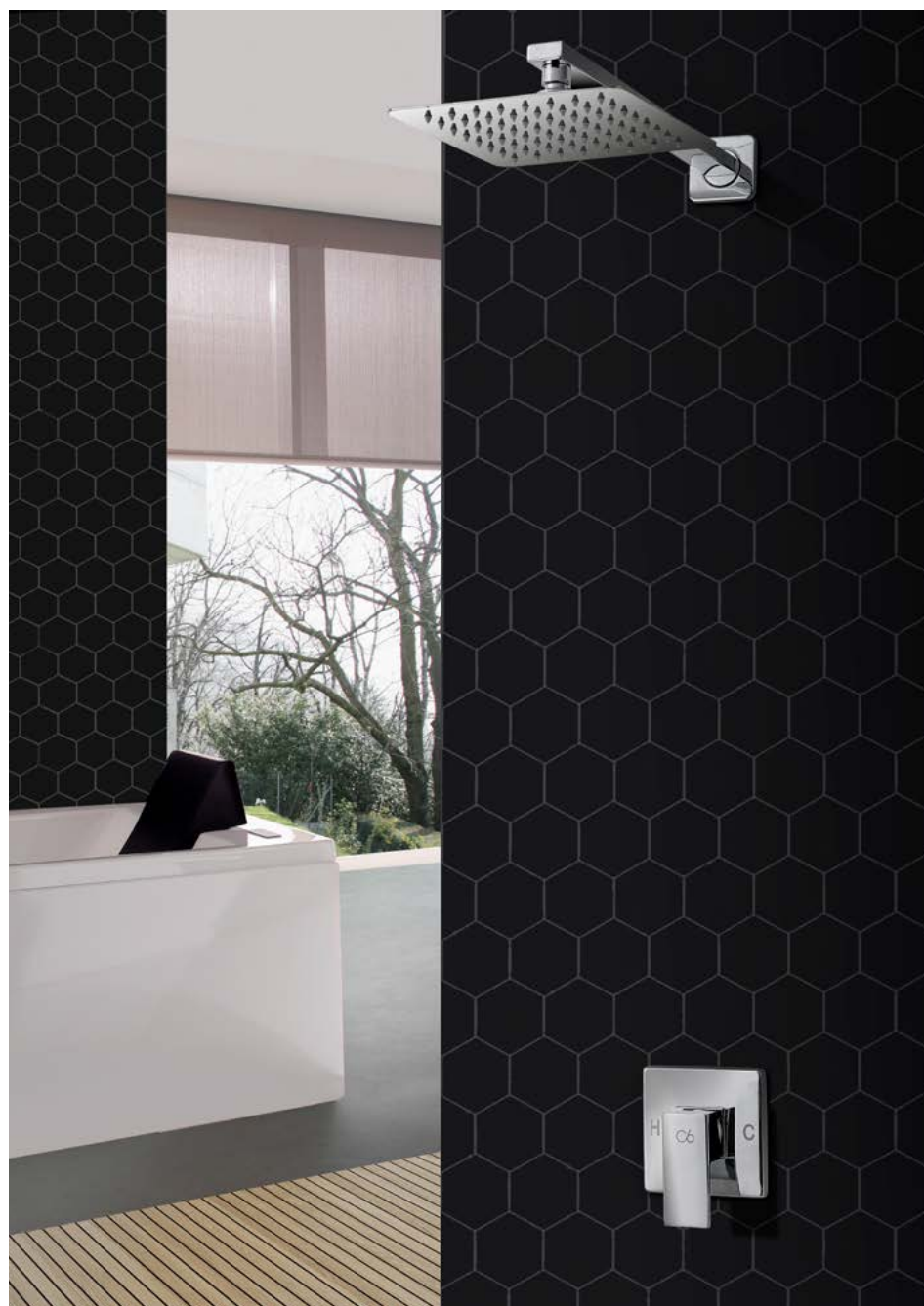

Serie **KU** 1 Vía

121012

Monomando empotrado de 1 vía

Rociador antical acero de 200x200 mm
Brazo de ducha de 1/2x37 cm

PVP: 128,00 €

Cuerpo en caja empotrable
Profundidad: 63 mm



Serie **KU** 2 Vía

121013

Monomando empotrado de 2 vías con distribuidor

Rociador antical acero de 200x200 mm
Flexo y teléfono
Brazo de ducha de 1/2x37 cm
Codo de ducha con soporte

PVP: 225,00 €

Cuerpo en caja empotrable
Profundidad: 63 mm





Serie **KU** 3 Vía



121007

Ducha empotrada / Built-in-mixer

1 vía
Acabado cromo

PVP: 80,00 €



121008

Ducha empotrada / Built-in-mixer

2 vías
Acabado cromo

PVP: 110,00 €



121015

Caño KU

PVP: 39,00 €



121132

Ducha empotrada / Built-in-mixer

3 vías
Acabado cromo

PVP: 135,00 €

121014

Monomando empotrado de 3 vías

Rociador antical acero de 200x200 mm
Flexo y teléfono
Brazo de ducha de 1/2
Codo de ducha con soporte
Caño de llenado

PVP: 290,00 €

Cuerpo en caja empotrable
Profundidad: 63 mm



Serie **KU** Negro

PVD



121001 NG

Monomando lavabo / Basin mixer

Acabado negro mate
Cartucho 25 mm.

PVP: 90,00 €

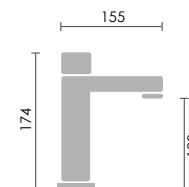

121001 NG

Monomando lavabo alto / Basin mixer

Acabado negro mate
Cartucho 25 mm.

PVP: 136,00 €

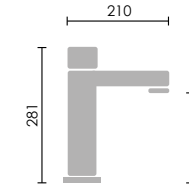

121002 NG

Monomando bidé / Bidet mixer

Acabado negro mate
Cartucho 25 mm.

PVP: 90,00 €

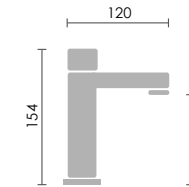

121009 NG

Monomando lavabo empotrado

/ In wall basin mixer

Acabado negro mate
Cartucho 35 mm.

PVP: 145,00 €

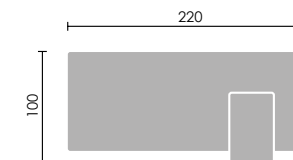

Serie **KU** Negro

122026 NG**Conjunto monomando**

Cartucho 35 mm
Barra extensible (de 800 a 1280 mm)
Rociador antical acero 200x250 mm
Flexo 1,7 PVC NEGRO
Ducha modelo 120 - 1 posición
Acabado negro mate

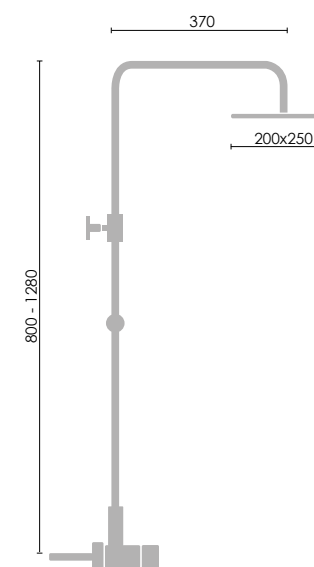
PVP: 288,00 €

Serie **KU** 2 Vía



121013NG

Conjunto Monomando Empotrado 2 VIAS

Rociador antical acero SS304 de 250x250 mm
 Monomando empotrado de 2 vías
 Caja registrable
 Brazo de ducha de 1/2x37 cm
 Salida para flexo c/ soporte integrado
 Flexo 1,7 PVC NEGRO
 Ducha de 1 posición
 Acabado: Negro

PVP: 275,00 €

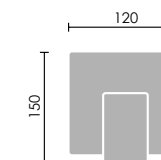

Cuerpo en caja empotrable Profundidad: 63 mm



121008NG

Grifo monomando empotrado 32 VIAS

Acabado negro
 Incluye caja registrable
 No incluye flexo ni mango de ducha

PVP: 145,00 €



Serie **KU** 3 Vía

121014NG

Conjunto Monomando Empotrado 3 VIAS

Rociador antical acero SS304 de 250x250 mm
 Monomando empotrado de 3 vías
 Caja registrable
 Brazo de ducha de 1/2x37 cm
 Salida para flexo c/ soporte integrado
 Flexo reforzado cromado 1,70 PVC
 Ducha de 1 posición
 Acabado: Negro

PVP: 340,00 €

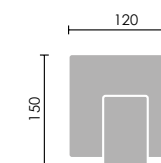

Cuerpo en caja empotrable Profundidad: 63 mm



121132NG

Grifo monomando empotrado 3 VIAS

Acabado negro
 Incluye caja registrable
 No incluye flexo ni mango de ducha

PVP: 185,00 €



121015NG

Caño KU

Acabado negro

PVP: 51,00 €



Serie CÍES



121521

Monomando lavabo / Basin mixer

Acabado cromo
Cartucho 35 mm.

PVP: 74,00 €

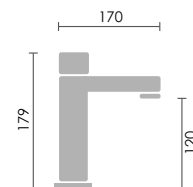

121522

Monomando bidé / Bidet mixer

Acabado cromo
Cartucho 35 mm.

PVP: 74,00 €

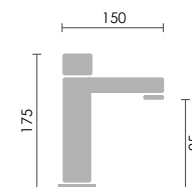

121523

Monomando baño ducha / Bathtub mixer

Acabado cromo
Cartucho 35 mm.

PVP: 115,00 €

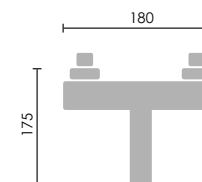

121524

Monomando ducha / Shower mixer

Acabado cromo
Cartucho 35 mm.

PVP: 82,00 €

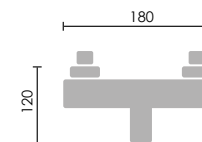

Incluido el kit de ducha. Flexo, mango de ducha y soporte.

ACS WRAS KTW
APPROVED PRODUCT
Cartuchos certificados.

Serie CÍES

122014

Monomando cartucho 35 mm

Barra extensible (de 870 a 1350 mm)
Rociador antical acero 200x250 mm
Flexo reforzado de 1,5-2,0
Ducha modelo 150 - 1 posición
Acabado cromo

PVP: 170,00 €

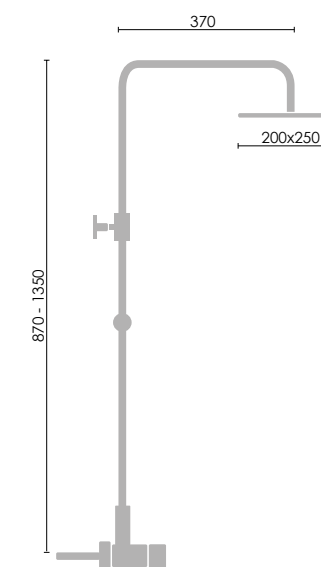

Serie **VARTA**



121421

Monomando lavabo / Basin mixer

Acabado cromo
Cartucho 35 mm.

PVP: 74,00 €

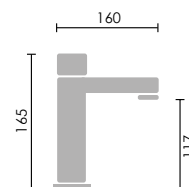

121425

Monomando lavabo alto / Basin mixer

Acabado cromo
Cartucho 35 mm.

PVP: 115,00 €

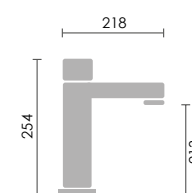

121422

Monomando bidé / Bidet mixer

Acabado cromo
Cartucho 35 mm.

PVP: 74,00 €

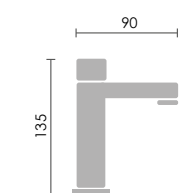

121423

Monomando baño ducha / Bathtub mixer

Acabado cromo
Cartucho 35 mm.

PVP: 110,00 €

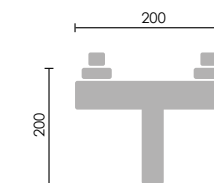

121424

Monomando ducha / Shower mixer

Acabado cromo
Cartucho 35 mm.

PVP: 70,00 €

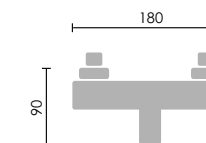

Incluido el kit de ducha. Flexo, mango de ducha y soporte.

ACS WRAS KTW
APPROVED PRODUCT
Cartuchos certificados.

Serie **VARTA**

122032

Conjunto monomando cartucho 35 mm

Barra extensible (de 870 a 1350 mm)
 Rociador antical acero 250x250 mm
 Flexo reforzado de 1,5-2,0
 Ducha modelo 150 1 posición
 Acabado cromo

PVP: 168,00 €

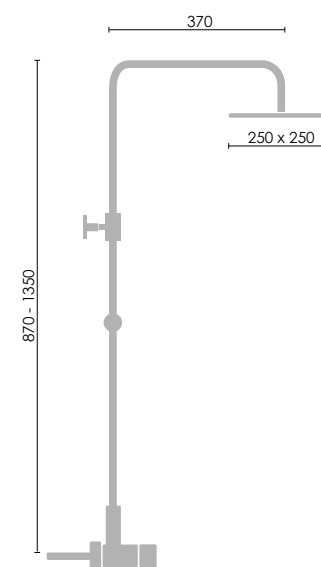

Serie YDRA



121201
Monomando lavabo / Basin mixer

Acabado cromo
Cartucho 35 mm.

PVP: 74,00 €

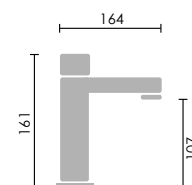

121203

Monomando baño ducha / Bathtub mixer

Acabado cromo
Cartucho 35 mm.

PVP: 105,00 €

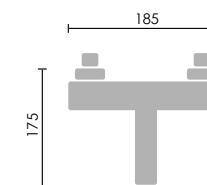

121204

Monomando ducha / Shower mixer

Acabado cromo
Cartucho 35 mm.

PVP: 88,00 €

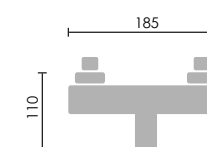

121202

Monomando bidé / Bidet mixer

Acabado cromo
Cartucho 35 mm.

PVP: 74,00 €

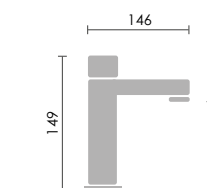

Incluido el kit de ducha. Flexo, mango de ducha y soporte.

ACS WRAS KTW
APPROVED PRODUCT
Cartuchos certificados.



Serie **YDRA**

clausy bath

Criferia de **BANO**

122034

Monomando cartucho 35 mm

Barra extensible (de 870 a 1350 mm)
Rociador antical acero 250 mm
Flexo reforzado 1,5-2,0 m
Ducha modelo 140 - 1 posición
Acabado cromo

PVP: 185,00 €

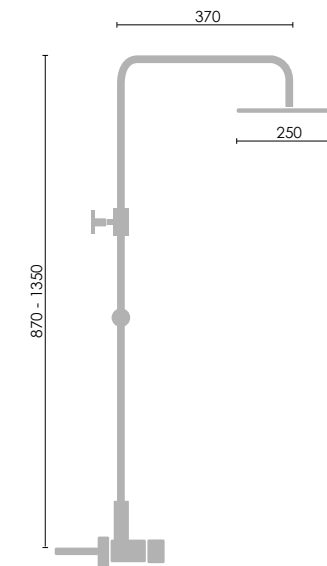

Serie BONN



121107

Monomando lavabo alto / Basin mixer

Acabado cromo
Cartucho 35 mm.

PVP: 92,00 €

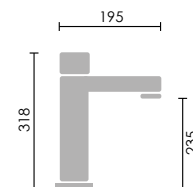

121101

Monomando lavabo / Basin mixer

Acabado cromo
Cartucho 35 mm.

PVP: 65,00 €

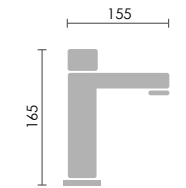

121102

Monomando bidé / Bidet mixer

Acabado cromo
Cartucho 35 mm.

PVP: 65,00 €

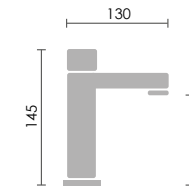

121104

Monomando ducha / Shower mixer

Acabado cromo
Cartucho 35 mm.

PVP: 88,00 €



121103

Monomando baño ducha / Bathtub mixer

Acabado cromo
Cartucho 35 mm.

PVP: 110,00 €

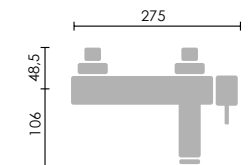

Incluido el kit de ducha. Flexo, mango de ducha y soporte.

ACS WRAS APPROVED PRODUCT KTW
Cartuchos certificados.

Serie **BONN**



121111

Monomando lavabo empotrado / In wall basin mixer

Acabado cromo
Cartucho 35 mm.

PVP: 115,00 €

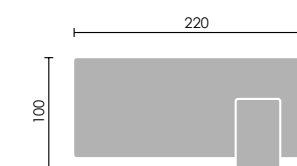

Cuerpo en caja empotrable
Profundidad: 63 mm



Serie **BONN** 1 Vía



Serie **BONN** 2 Vías

121119

Monomando empotrado de 1 vía

Rociador antical acero de 200 mm
Brazo de ducha de 1/2x37 cm

PVP: 118,00 €

Cuerpo en caja empotrable

Profundidad: 63 mm



121120

Monomando empotrado de 2 vías con distribuidor

Rociador antical acero de 200 mm
Flexo y teléfono
Brazo de ducha de 1/2x37 cm
Codo de ducha con soporte

PVP: 200,00 €

Cuerpo en caja empotrable

Profundidad: 63 mm



Serie **BONN** 3 Vías



121121

Monomando empotrado de 3 vías con distribuidor

Rociador antical acero de 200 mm
Flexo y teléfono
Brazo de ducha de 1/2x37 cm
Codo de ducha con soporte
Caño de llenado

PVP: 250,00 €



121110

Ducha empotrada con distribuidor / Built-in-mixer

2 vías
Acabado cromo

PVP: 105,00 €



121809

Ducha empotrada / Built-in-mixer

1 vía
Acabado cromo

PVP: 69,00 €



121122

Caño Bonn

PVP: 35,00 €

Cuerpo en caja empotrable

Profundidad: 63 mm



121131

Ducha empotrada con distribuidor / Built-in-mixer

3 vías
Acabado cromo

PVP: 128,00 €

Serie **BONN**

122011

Conjunto monomando

Cartucho 35 mm
 Barra extensible (de 870 a 1350 mm)
 Rociador antical acero 200 mm
 Flexo reforzado 1,5-2,0 m
 Ducha modelo 300 - 3 posiciones
 Acabado cromo

PVP: 165,00 €

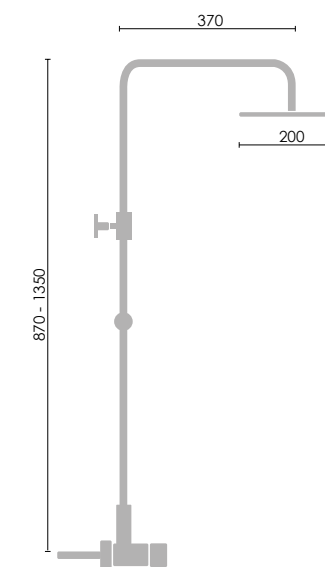

Serie **KOBA**



121801

Monomando lavabo / Basin mixer

Acabado cromo
Cartucho 35 mm.

PVP: 59,00 €

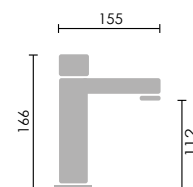

121806

Monomando lavabo alto / Basin mixer

Acabado cromo
Cartucho 35 mm.

PVP: 98,00 €

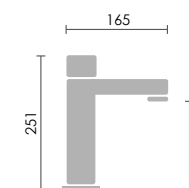

121802

Monomando bidé / Bidet mixer

Acabado cromo
Cartucho 35 mm.

PVP: 59,00 €

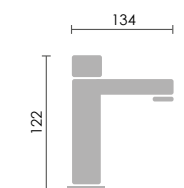

121803

Monomando baño ducha / Bathtub mixer

Acabado cromo
Cartucho 35 mm.

PVP: 86,00 €

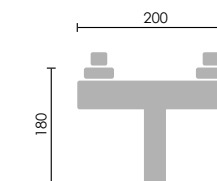

121804

Monomando ducha / Shower mixer

Acabado cromo
Cartucho 35 mm.

PVP: 70,00 €

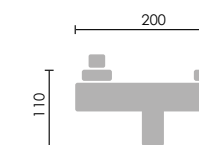

Incluido el kit de ducha. Flexo, mango de ducha y soporte.

ACS WRAS KTW
APPROVED PRODUCT
Cartuchos certificados.



Serie **KOBA**

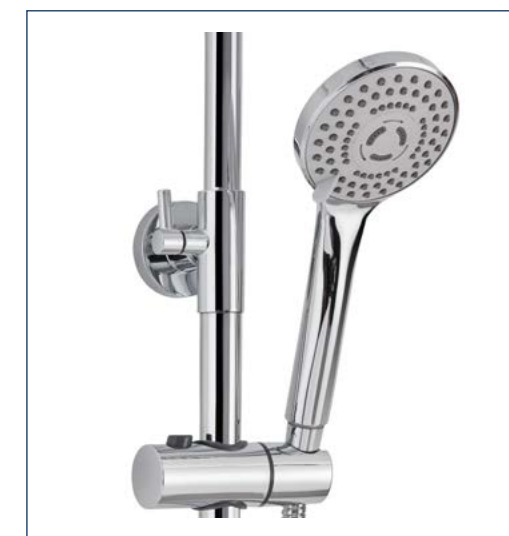

122029

Conjunto monomando

- Cartucho 35 mm
- Barra extensible (de 870 a 1350 mm)
- Rociador antical acero 250 mm
- Flexo reforzado 1,5-2,0 m
- Ducha de 3 posiciones modelo 300
- Acabado cromo

PVP: 165,00 €

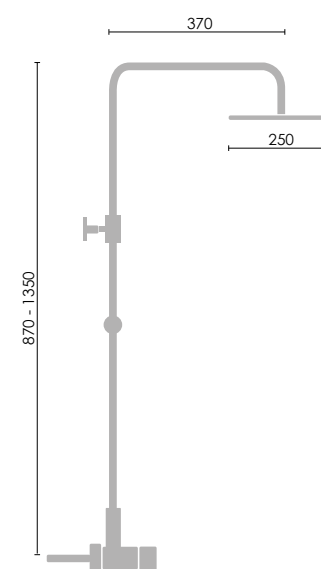



Serie **KOBA II**

122036

Conjunto monomando

Barra extensible de latón (de 800 a 1280 mm)
 Rociador antical acero 250 mm
 Flexo reforzado de 1,5-2,0 mm
 Ducha de 3 posiciones modelo 300
 Acabado cromo
 Cartucho 35 mm
 Apertura en frío

PVP: 192,00 €

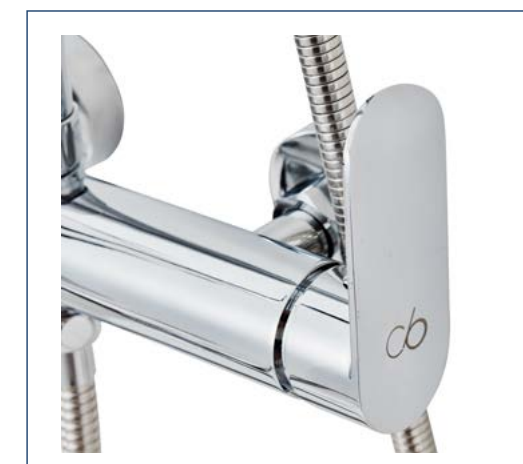
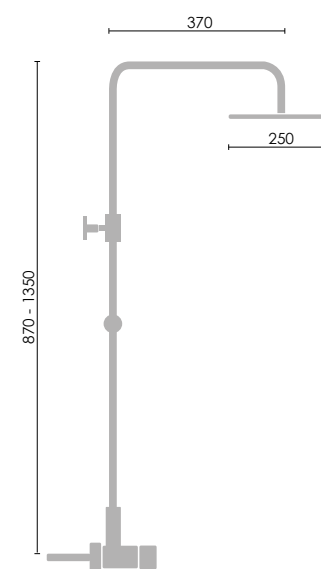

121814

Monomando lavabo empotrado / In wall basin mixer

Acabado cromo
 Cartucho 35 mm.

PVP: 110,00 €

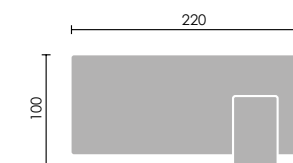

Incluido el kit de ducha. Flexo, mango de ducha y soporte.

ACS WRAS KTW
 APPROVED PRODUCT
 Cartuchos certificados.

Serie **KOBA** Negro

PVD



121801 NG

Monomando lavabo / Basin mixer

Acabado negro mate
Cartucho 35 mm

PVP: 74,00 €

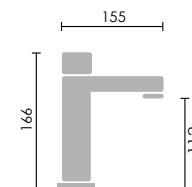

121802 NG

Monomando bidé / Bidet mixer

Acabado negro mate
Cartucho 35 mm

PVP: 74,00 €

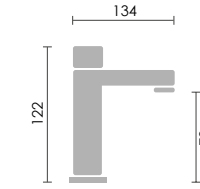

121806 NG

Monomando lavabo alto / Basin mixer

Acabado negro mate
Cartucho 35 mm.

PVP: 115,00 €

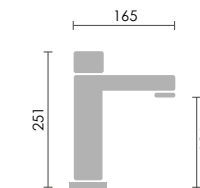

121814 NG

Monomando lavabo empotrado
/ In wall basin mixer

Acabado negro mate
Cartucho 35 mm.

PVP: 125,00 €

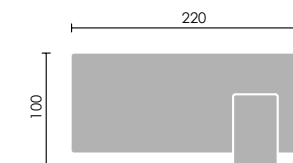

Incluido el kit de ducha. Flexo, mango de ducha y soporte.

ACS WRAS KTW
APPROVED PRODUCT
Cartuchos certificados.

Serie **KOBA** Negro

122029NG

Conjunto monomando

Cartucho 35 mm
 Barra extensible (de 870 a 1350 mm)
 Rociador antical acero 250 mm
 Flexo 1,7 PVC NEGRO
 Ducha de 3 posiciones modelo 320
 Acabado negro

PVP: 195,00 €

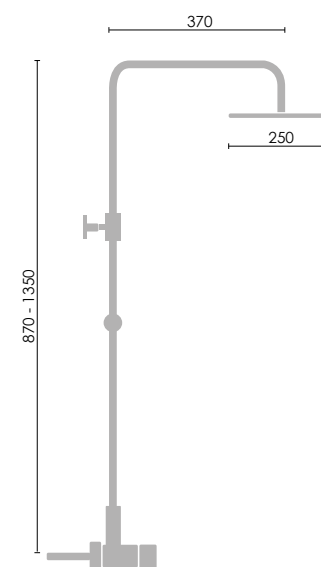

Serie **KOBA** Negro



122036 NG

Monomando

Barra extensible de latón (de 800 a 1280 mm)
 Rociador antical acero 250 mm
 Flexo 1,7 PVC NEGRO
 Ducha de 5 posiciones modelo 320
 Acabado negro
 Cartucho 35 mm
 Apertura en frío

PVP: 235,00 €

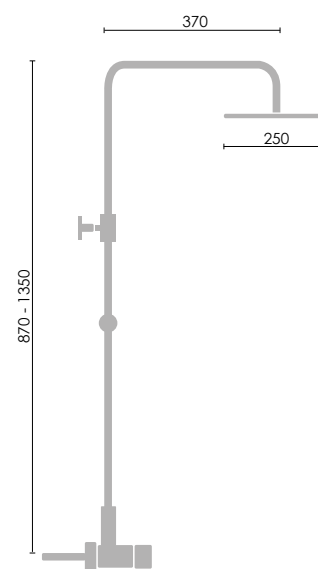

Serie **KOBA** Oro

PVD



121814 OR

Monomando lavabo empotrado/ In wall basin mixer

Acabado oro
Cartucho 35 mm.

PVP: 130,00 €

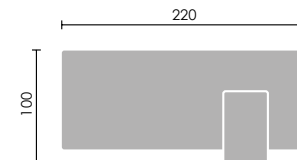

121801 OR

Monomando lavabo / Basin mixer

Acabado oro
Cartucho 35 mm.

PVP: 78,00 €

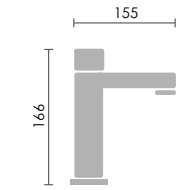

121802 OR

Monomando bidé / Bidet mixer

Acabado oro
Cartucho 35 mm.

PVP: 78,00 €

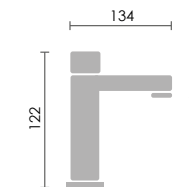

121806 OR

Monomando lavabo alto / Basin mixer

Acabado oro
Cartucho 35 mm.

PVP: 120,00 €

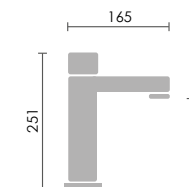

Incluido el kit de ducha. Flexo, mango de ducha y soporte.

ACS WRAS KTW
APPROVED PRODUCT
Cartuchos certificados.

Serie **KOBA II** Oro



122036 OR

Monomando

Barra extensible de latón (de 800 a 1280 mm)
 Rociador antical acero 250 mm
 Flexo 1,7 PVC ORO
 Ducha de 5 posiciones modelo 330
 Acabado oro
 Cartucho 35 mm
 Apertura en frío

PVP:268,00 €

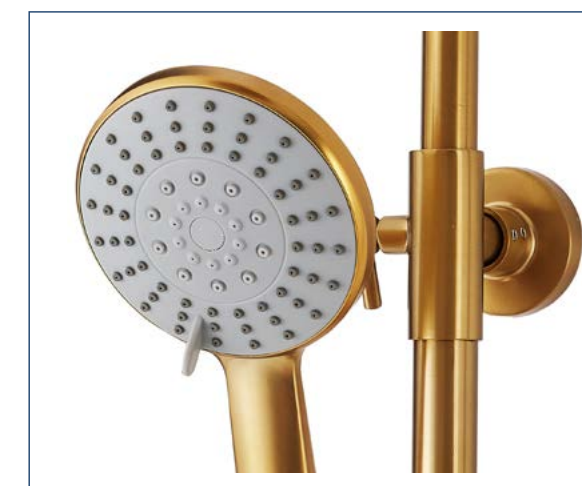
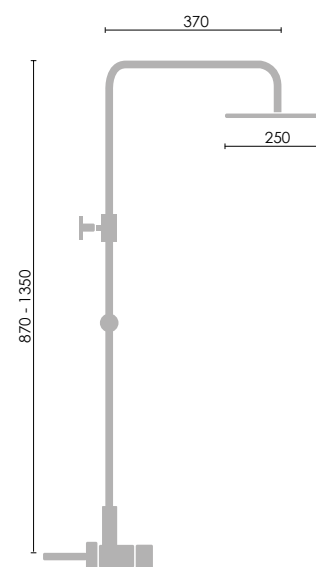

Serie JADE



121216

Monomando lavabo alto / Basin mixer

Acabado cromo
Cartucho 25 mm.

PVP: 95,00 €

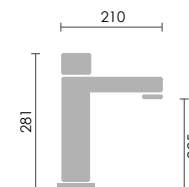

121211

Monomando lavabo / Basin mixer

Acabado cromo
Cartucho 25 mm.

PVP: 53,00 €

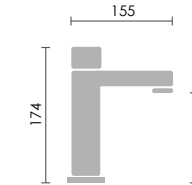

121212

Monomando bidé / Bidet mixer

Acabado cromo
Cartucho 25 mm.

PVP: 53,00 €

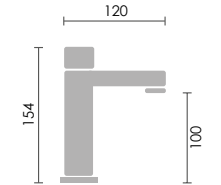

121213

Monomando baño ducha / Bathtub mixer

Acabado cromo
Cartucho 35 mm.

PVP: 98,00 €

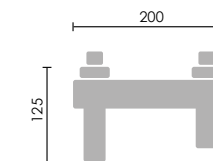

121214

Monomando ducha / Shower mixer

Acabado cromo
Cartucho 35 mm.

PVP: 68,00 €

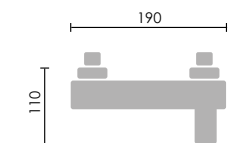

Incluido el kit de ducha. Flexo, mango de ducha y soporte.



Serie **JADE**

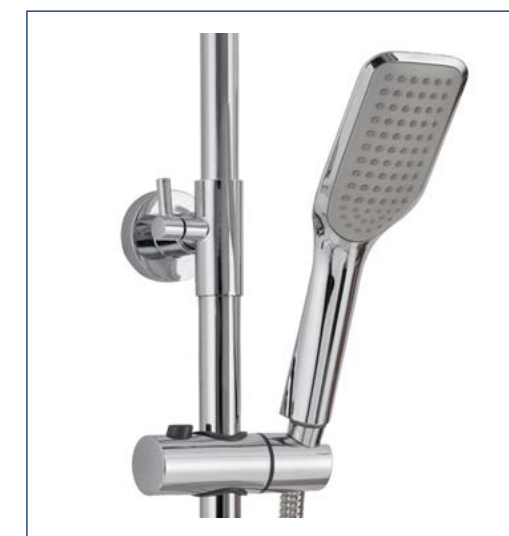

122027

Monomando cartucho 35 mm

Barra extensible (de 870 a 1350 mm)
Rociador antical acero 200x250 mm
Flexo reforzado 1,5-2,0 m
Ducha modelo 140 - 1 posición
Acabado cromo

PVP: 160,00 €



Serie **JADE II**

122021

Conjunto Monomando cartucho 35 mm

Barra extensible (de 870 a 1350 mm)
 Rociador antical acero 250 mm
 Flexo reforzado de 1,5-2,0
 Ducha modelo 140 - 1 posición
 Acabado cromo

PVP: 188,00 €

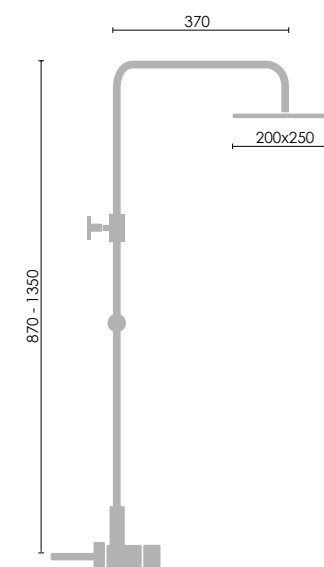

Serie **JADE**

121221

Conjunto Monomando

Rociador antical acero SS304 de 250 mm
 Monomando empotrado de 2 vías
 Caja registrable
 Brazo de ducha de 1/2x37 cm
 Codo de ducha c/ soporte integrado
 Flexo reforzado cromado 1,50-2,0 m.
 Ducha de 3 posiciones
 Acabado: Cromo

PVP: 188,00 €

121218

Grifo monomando empotrado

Acabado cromo
 Incluye caja registrable
 No incluye flexo ni mango de ducha

PVP: 100,00 €

No incluye flexo ni mango de ducha



Serie **JADE** Negro

PVD



121211NG

Monomando lavabo / Basin mixer

Acabado negro
Cartucho 25 mm.

PVP: 68,00 €

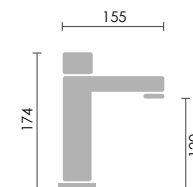

121216NG

Monomando lavabo alto / Basin mixer

Acabado negro
Cartucho 25 mm.

PVP: 110,00 €

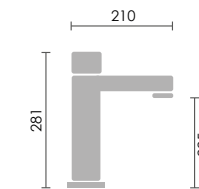

121212NG

Monomando bidé / Bidet mixer

Acabado negro
Cartucho 25 mm.

PVP: 68,00 €

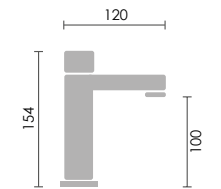

121213NG

Monomando baño ducha / Bathtub mixer

Acabado negro
Cartucho 35 mm.

PVP: 122,00 €

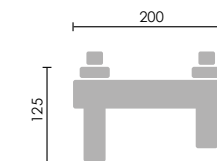

121214NG

Monomando ducha / Shower mixer

Acabado negro
Cartucho 35 mm.

PVP: 89,00 €

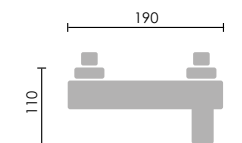

Incluido el kit de ducha. Flexo, mango de ducha y soporte.

Serie **JADE** Negro

122021NG

Conjunto Monomando

Rociador antical acero SS304 de 200 mm
 Monomando empotrado de 2 vías
 Caja registrable
 Brazo de ducha de 1/2x37 cm
 Salida para flexo c/ soporte integrado
 Flexo PVC 1,7 m.
 Ducha de 3 posiciones
 Acabado: Negro mate

PVP: 225,00 €

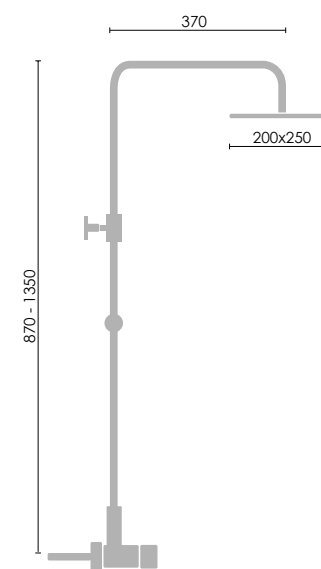

Serie **JADE II** Negro

122027NG

Conjunto Monomando cartucho 35 mm

Barra extensible (de 870 a 1350 mm)
Rociador antical acero DE 200x250 mm
Flexo 1,7 PVC NEGRO
Ducha modelo 300 - 3 posición
Acabado negro

PVP: 208,00 €

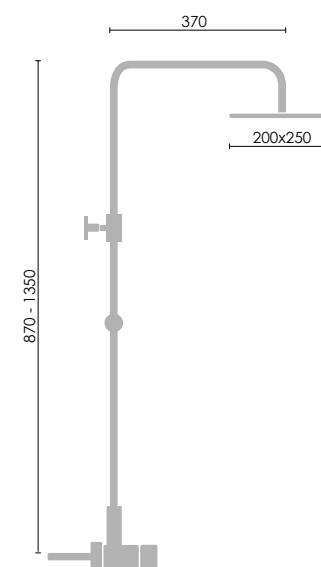

Serie **JADE** Negro

121221NG

Conjunto Monomando

Rociador antical acero SS304 de 250 mm
 Monomando empotrado de 2 vías
 Caja registrable
 Brazo de ducha de 1/2x37 cm
 Codo de ducha c/ soporte integrado
 Flexo 1,7 PVC NEGRO
 Ducha de 3 posiciones
 Acabado: negro

PVP: 225,00 €

121218NG

Grifo monomando empotrado

Acabado negro
 Incluye caja registrable
 No incluye flexo ni mango de ducha

PVP: 120,00 €

No incluye flexo ni mango de ducha



Serie ZURICH



121911

Monomando lavabo / Basin mixer

Acabado cromo
Cartucho 35 mm.

PVP: 44,00 €

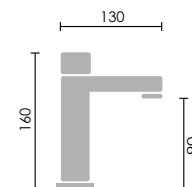

121912

Monomando bidé / Bidet mixer

Acabado cromo
Cartucho 35 mm.

PVP: 44,00 €

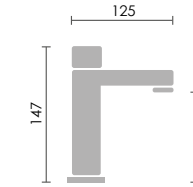

121913

Monomando baño ducha / Bathtub mixer

Acabado cromo
Cartucho 35 mm.

PVP: 80,00 €

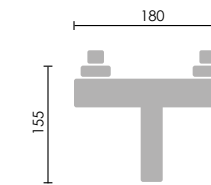

121914

Monomando ducha / Shower mixer

Acabado cromo
Cartucho 35 mm.

PVP: 61,00 €

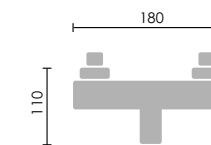

Incluido el kit de ducha. Flexo, mango de ducha y soporte.

ACS WRAS KTW
APPROVED PRODUCT
Cartuchos certificados.



Serie **ZURICH** Redondo

122019

Rociador redondo

Barra extensible (de 870 a 1350 mm)
Rociador antical acero 200 mm
Flexo reforzado 1.5-2.0 m
Ducha modelo 300 - 3 posición
Acabado cromo

PVP: 152.00 €



Serie **ZURICH** Cuadrado

122025

Rociador cuadrado

Barra extensible (de 870 a 1350 mm)
Rociador antical acero 200x200 mm
Flexo reforzado 1.5-2.0 m
Ducha modelo 150 - 1 posición
Acabado cromo

PVP: 155.00 €



Serie ALFA



121301

Monomando lavabo / Basin mixer

Acabado cromo
Cartucho 40 mm.

PVP: 34,00 €

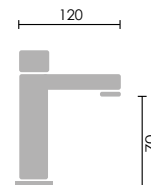

121302

Monomando bidé / Bidet mixer

Acabado cromo
Cartucho 40 mm.

PVP: 34,00 €



121303

Monomando baño ducha / Bathtub mixer

Acabado cromo
Cartucho 40 mm.

PVP: 65,00 €

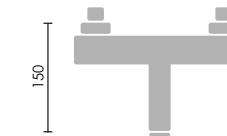

121304

Monomando ducha / Shower mixer

Acabado cromo
Cartucho 40 mm.

PVP: 50,00 €



Incluido el kit de ducha. Flexo, mango de ducha y soporte.

ACS WRAS APPROVED PRODUCT KTW
Cartuchos certificados.

Serie CLASSIC Cromo



121401

Monobloc lavabo / Mono basin mixer

Acabado cromo
Montura cerámica 1/4 v

PVP: 98,00 €

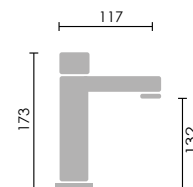

121402

Monobloc bidé / Mono bidet mixer

Acabado cromo
Montura cerámica 1/4 v

PVP: 98,00 €

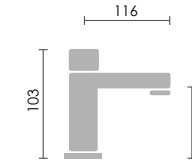

121403

Monobloc baño ducha / Bathtub mixer

Acabado cromo
Montura cerámica 1/4 v

PVP: 145,00 €

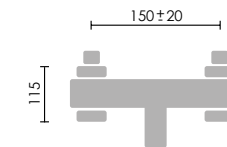

121404

Monobloc ducha / Shower mixer

Acabado cromo
Montura cerámica 1/4 v

PVP: 88,00 €

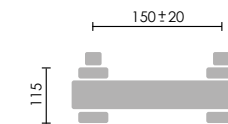

Incluido el kit de ducha. Flexo, mango de ducha y soporte.

Serie **CLASSIC** Cromo

122015

Grifería bimando montura cerámica 1/4 v

Barra extensible (de 870 a 1350 mm)
 Rociador antical acero 200 mm
 Flexo reforzado 1,5-2,0 m
 Ducha classic - 1 posición
 Acabado cromo

PVP: 295,00 €

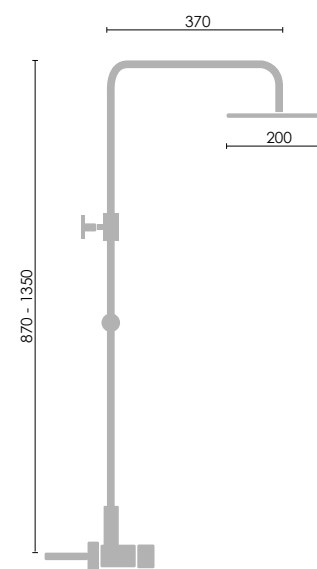

Serie CLASSIC Bronce



121411

Monobloc lavabo / Mono basin mixer

Acabado bronce
Montura cerámica 1/4 v

PVP: 115,00 €

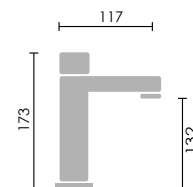

121412

Monobloc bidé / bidet mixer

Acabado bronce
Montura cerámica 1/4 v

PVP: 115,00 €

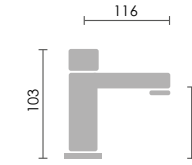

121413

Monobloc baño ducha / Bathtub mixer

Acabado bronce
Montura cerámica 1/4 v

PVP: 175,00 €

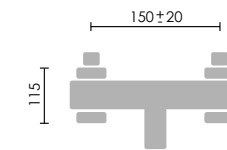

121414

Monobloc ducha / Shower mixer

Acabado bronce
Montura cerámica 1/4 v

PVP: 114,00 €

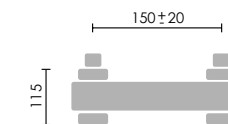

Incluido el kit de ducha. Flexo, mango de ducha y soporte.

Conjuntos de DUCHA

■ Serie ÁRTICO	158 / 159
■ Serie ÁRTICO NEGRO	160 / 161
■ Serie BANI	162 / 163
■ Serie BAN NEGRO I	164 / 165
■ Serie ÍNDICO	166 / 167
■ Serie ÍNDICO NEGRO	168 / 169
■ Serie ÍNDICO ORO	170 / 171 /
■ Serie ÍNDICO ROSA	172 / 173
■ Serie ÍNDICO GRIS METAL	174 / 175
■ Serie ÍNDICO BLANCO	176 / 177
■ Serie ANDROS	178 / 179
■ Serie TERES	180 / 181
■ Serie INDO	182 / 183
■ Serie INDO NEGRO	184 / 185
■ Serie KRONOS	186 / 187
■ Serie KRONOS NEGRO	188 / 189
■ Serie COOPER	190 / 191
■ Serie COOPER NEGRO	192 / 193
■ Serie OLIMPIC	194
■ Serie TITANIC	195

Serie **ÁRTICO**

122004

Conjunto Termostático Cartucho Cítec

Barra extensible de latón (de 870 a 1280 mm)
Rociador antical acero 200x250 mm
Flexo y teléfono modelo 150
Acabado cromo
Volantes metálicos

PVP: 290,00 €

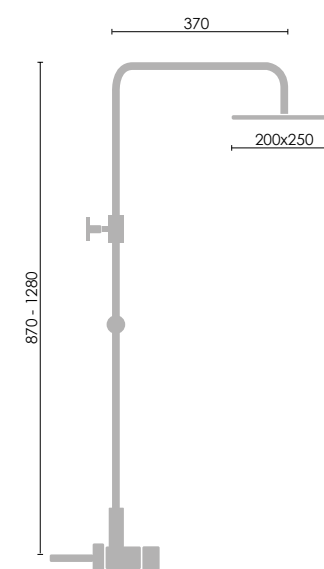



Serie **ÁRTICO** Negro

PVD

122004 NG

Conjunto Termostático Cartucho Citec

Barra extensible de latón (de 870 a 1280 mm)
Rociador antical acero 200x250 mm
Flexo y teléfono
Acabado negro
Volantes metálicos

PVP: 320,00 €

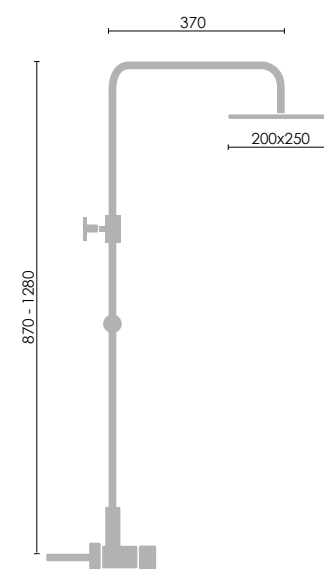

Serie **BANI**

122037

Conjunto Termostático Cartucho Citec

Barra extensible de latón (de 870 a 1280 mm)
Rociador antical acero 200x250 mm
Flexo y teléfono modelo 150
Acabado cromo
Volantes metálicos

PVP: 240,00 €

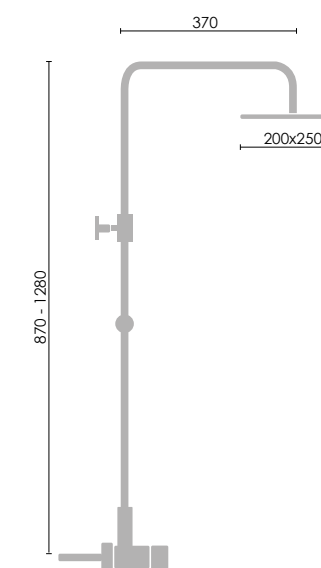

Serie **BANI** Negro

122037 NG

Conjunto Termostático Cartucho Citec

Barra extensible de latón (de 870 a 1280 mm)
Rociador antical acero 200x250 mm
Flexo y teléfono
Acabado negro
Volantes metálicos

PVP: 265,00 €

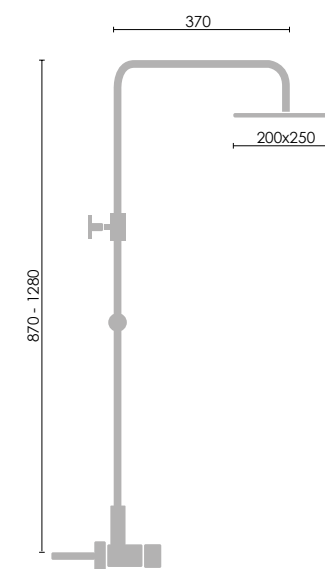

Serie ÍNDICO

122003

**Conjunto Termostático
Cartucho Cítec**

Barra extensible de latón (de 800 a 1280 mm)
Rociador antical acero 250 mm
Flexo reforzado 1,5-2,0 m
Ducha de 5 posiciones modelo 500
Acabado cromo
Volantes metálicos

PVP: 225,00 €

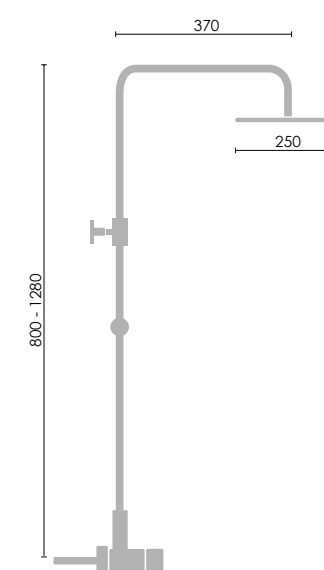
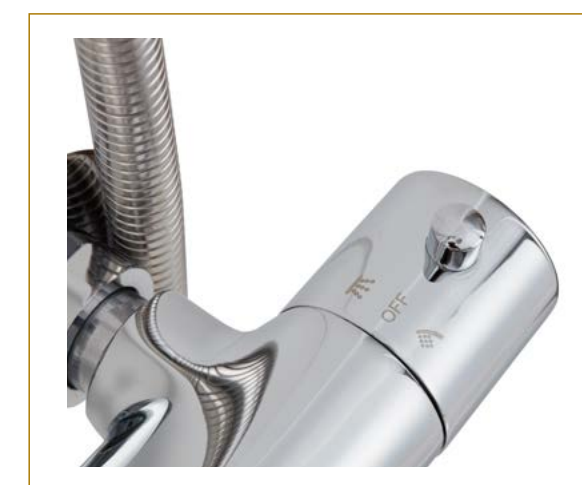

Serie **ÍNDICO** Negro

PVD



122003 NG

Conjunto Termostático Cartucho Cítec

Barra extensible de latón (de 800 a 1280 mm)
Rociador antical acero 250 mm
Flexo 1,7 PVC NEGRO
Ducha de 5 posiciones modelo 320
Acabado negro
Volantes metálicos

PVP: 245,00 €

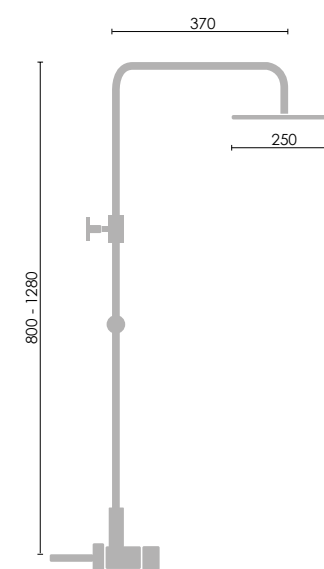

Serie **ÍNDICO** oro

PVD

**122003OR****Conjunto Termostático
Cartucho Cítec**

Barra extensible de latón (de 800 a 1280 mm)
 Rociador antical acero 250 mm
 Flexo 1,7 PVC ORO
 Ducha de 5 posiciones modelo 330
 Acabado oro cepillado
 Volantes metálicos

PVP: 310,00 €

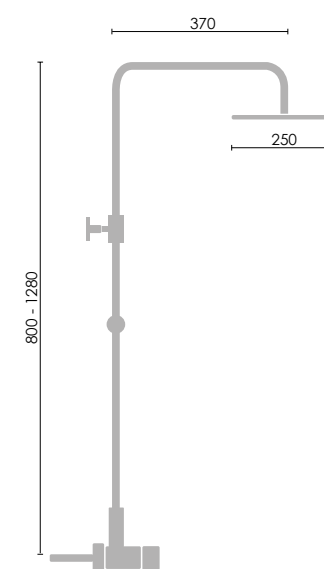

Serie **ÍNDICO** rosa

PVD

**122003RC****Conjunto Termostático
Cartucho Cítec**

Barra extensible de latón (de 800 a 1280 mm)
 Rociador antical acero 250 mm
 Flexo 1,7 PVC ROSA
 Ducha de 5 posiciones modelo 360
 Acabado rosa cepillado
 Volantes metálicos

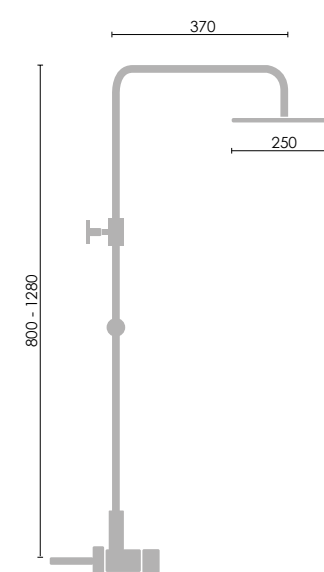
PVP: 320,00 €

Serie **ÍNDICO** Gris metal PVD



122003GM

Conjunto Termostático Cartucho Cítec

Barra extensible de latón (de 800 a 1280 mm)
Rociador antical acero 250 mm
Flexo 1,7 PVC GRIS
Ducha de 5 posiciones modelo 320
Acabado gris metal
Volantes metálicos

PVP: 320,00 €

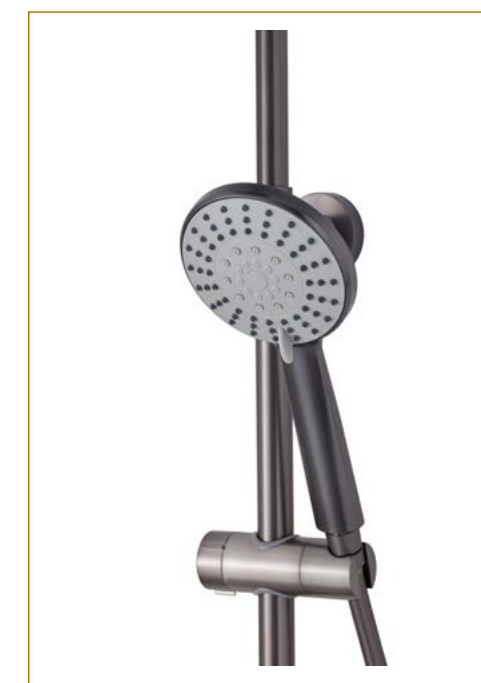
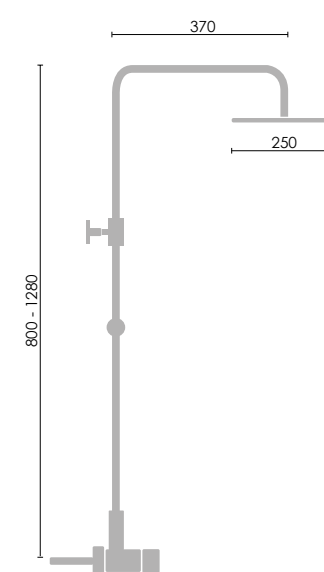

Serie **ÍNDICO** Blanco

122003 BL

Conjunto Termostático Cartucho Cítec

Barra extensible de latón (de 800 a 1280 mm)
Rociador antical acero 250 mm
Flexo 1,7 PVC BLANCO
Ducha de 5 posiciones modelo 340
Acabado blanco
Volantes metálicos

PVP: 245,00 €

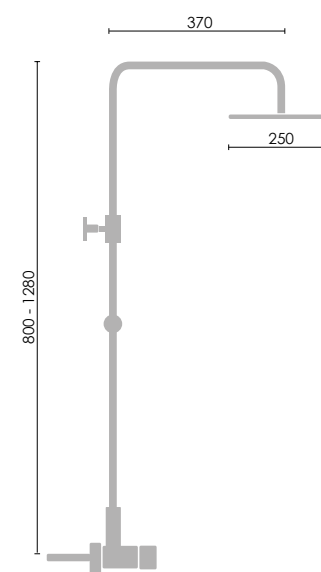

Serie **ANDROS**

122017

**Conjunto Termostático
Cartucho Citec**

Barra extensible de latón (de 800 a 1280 mm)
Rociador antical acero 200 mm
Flexo reforzado 1,5-2,0 m
Ducha de 3 posiciones modelo 300
Acabado cromo
Volantes ABS

PVP: 198,00 €

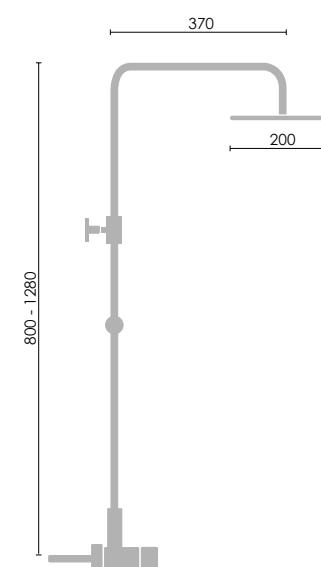

Serie **TERES** Bañera



122028

Conjunto Termostático de bañera

Barra extensible (de 1100 a 1500 mm)
Rociador antical acero 250 mm
Flexo reforzado 1,5-2,0 m
Ducha de 3 posiciones modelo 300
Acabado cromo

PVP: 295,00 €

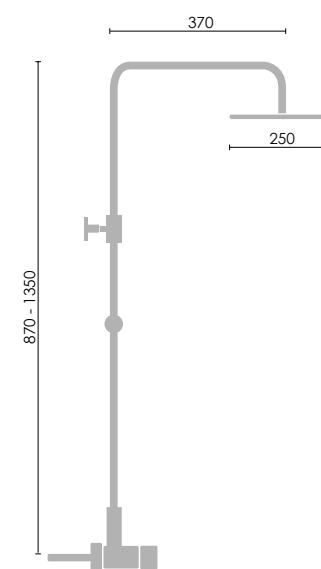

Inversor incorporado en la grifería



Serie **INDO**

122031

Conjunto monomando

Barra extensible de latón (de 870 a 1350 mm)
 Rociador antical acero 200x250 mm
 Flexo reforzado de 1,5-2,0 m
 Ducha de 1 posición modelo 150
 Acabado cromo
 Cartucho 35 mm

PVP: 168,00 €

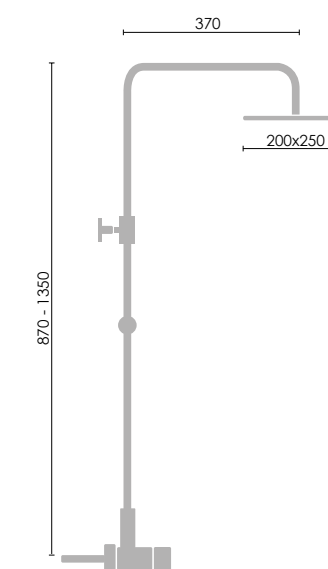

Serie **INDO** Negro



122031 NG

Conjunto monomando

Barra extensible (de 870 a 1350 mm)
 Rociador antical acero 200x250 mm
 Flexo 1,7 PVC NEGRO
 Ducha de 1 posición
 Acabado negro
 Cartucho 35 mm

PVP: 186,00 €

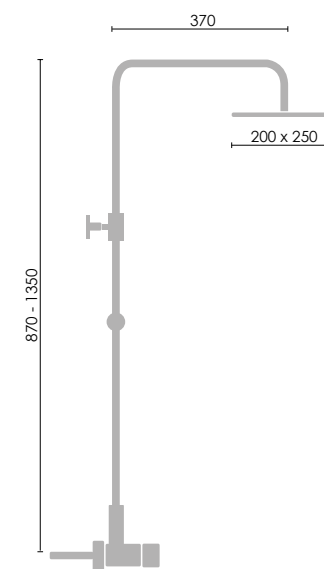

Serie **KRONOS**

122002

Conjunto monomando

Barra extensible de latón (de 800 a 1280 mm)
 Rociador antical acero 250 mm
 Flexo reforzado de 1,5-2,0 mm
 Ducha de 3 posiciones modelo 300
 Acabado cromo
 Cartucho 35 mm
 Apertura en frío

PVP: 195,00 €

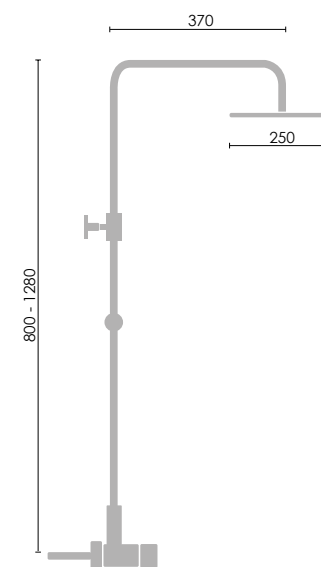

121114

Monomando de ducha

PVP: 85,00 €





Serie **KRONOS** Negro

PVD

122002 NG

Conjunto monomando

- Barra extensible de latón (de 800 a 1280 mm)
- Rociador antical acero 250 mm
- Flexo 1,7 PVC NEGRO
- Ducha de 5 posiciones modelo 320
- Acabado negro
- Cartucho 35 mm
- Apertura en frío

PVP: 230,00 €

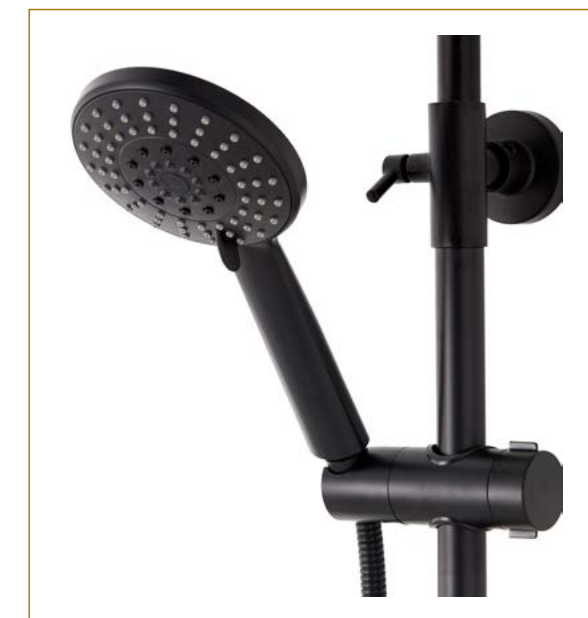
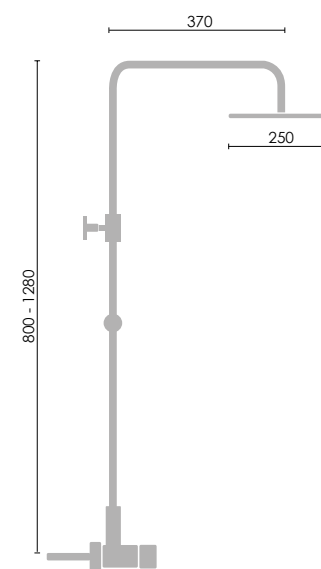

Serie **COOPER** Bañera



122033

Conjunto monomando bañera

Barra extensible (de 1000 a 1550 mm)
Rociador acero 200x250 mm
Flexo reforzado de 1,5-2,0 m
Ducha de 1 posición modelo 150
Acabado cromo

PVP: 285,00 €

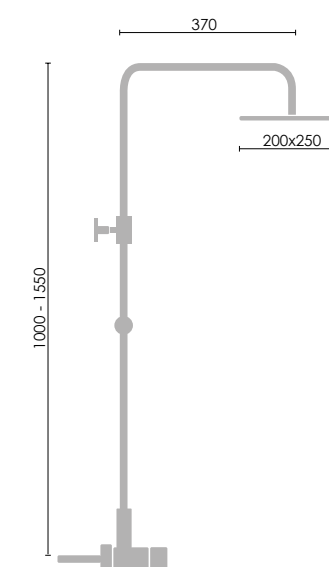

Serie **COOPER** Negro



122033NG

Conjunto Monomando BAÑERA

Cartucho 35 mm
 Barra extensible (de 870 a 1550 mm)
 Distribuidor cerámico
 Rociador antical acero 250 mm
 Flexo 1,7 PVC NEGRO
 Ducha modelo 300 - 3 posición
 Acabado: Negro

PVP: 320,00 €

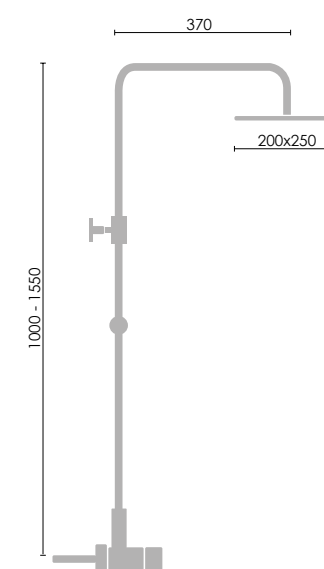

Serie OLIMPIC



122022

Conjunto de barra, rociador y ducha

Tubo telescópico de 700 a 1180 mm
 Barra ϕ 25 mm
 Distribuidor, soporte ajustable
 Flexo de 1,7 m. y conexión de 0,70 m
 Rociador de acero
 Ducha de 3 posiciones

PVP: 118,00 €

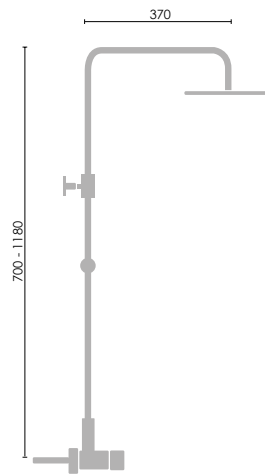

Serie TITANIC



122023

Conjunto de barra, rociador y ducha

Tubo telescópico de 800 a 1280 mm
 Barra ϕ 25 mm
 Distribuidor, soporte ajustable
 Flexo de 1,7 m. y conexión de 0,70 m
 Rociador de 200x200 mm
 Ducha de 1 posición

PVP: 118,00 €

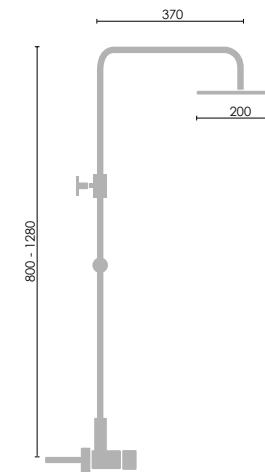

Conjuntos EMPOTRADOS

■ Serie TÍBER	198 / 199
■ Serie TÍBER NEGRO	200 / 201
■ Serie GOBI	202 / 203
■ Serie ARAS	204 / 205
■ Serie ARAS NEGRO	206 / 207
■ Serie ARAS ORO	208 / 209
■ Serie CUBE	210 / 211
■ Serie CUBE NEGRO	212 / 213
■ Serie Bol	214 / 215
■ Serie KRABI	216 / 217
■ Serie KRABI NEGRO	218 / 219
■ Serie KRABI ORO	220 / 221
■ Serie KRABI ROSA	222 / 223
■ Serie KRABI GRIS METAL	224 / 225

Serie TÍBER

121024

Conjunto monomando empotrado

Rociador antical acero SS304 de 250x250 mm
 Monomando empotrado de 2 vías
 Caja registrable
 Brazo de ducha de 1/2x37 cm
 Salida para flexo c/ soporte integrado
 Flexo reforzado cromado 1,50-2,0 m.
 Ducha de 1 posición
 Acabado: Cromo

PVP: 255,00 €

121030

Grifo monomando empotrado cromo

Incluye caja registrable
 No incluye flexo ni mango de ducha

PVP: 160,00 €

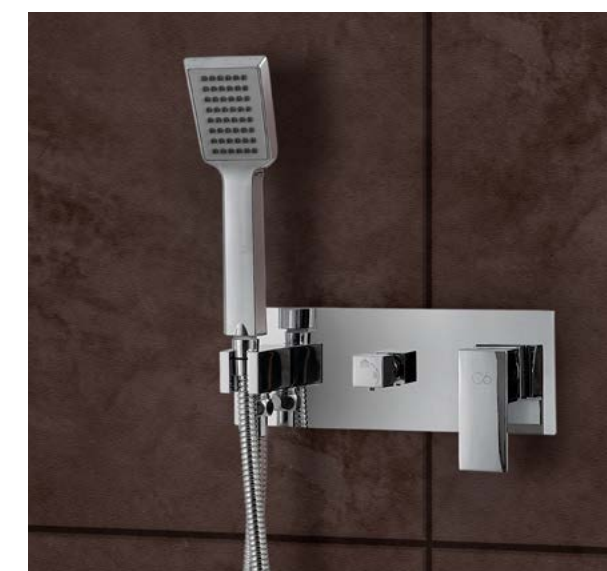
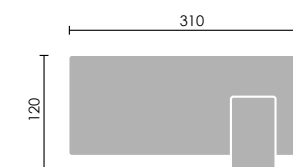

Serie TÍBER Negro

PVD

121024 NG

Conjunto monomando empotrado de 2 vías

Caja registrable
 Rociador antical acero SS304 de 250x250 mm
 Brazo de ducha de 1/2x37 cm
 Salida para flexo con soporte integrado
 Flexo 1.7 PVC NEGRO
 Ducha de 1 posición
 Acabado: Negro mate

PVP: 310,00 €

121030NG

Grifo monomando empotrado negro mate

Incluye caja registrable
 No incluye flexo ni mango de ducha

PVP: 188,00 €

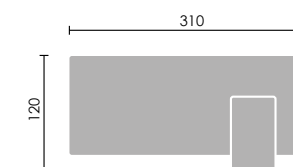

Serie GOBI

121021

Conjunto monomando empotrado de 2 vías

Caja registrable
 Incluye premarco de acero SS304
 Salida para flexo c/soporte integrado
 Flexo reforzado cromado 1,50-2,0 m
 Ducha de 1 posición
 Acabado cromo
 Rociador antical acero SS304 de 300x300 mm

PVP: 330,00 €

121021 - 40

Rociador antical acero SS304 de 400x400 mm

PVP: 365,00 €

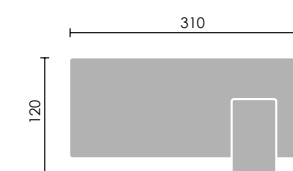

Serie **ARAS**

121135

Conjunto monomando empotrado

Rociador antical acero SS304 de 250 mm
 Monomando empotrado de 2 vías
 Caja registrable
 Brazo de ducha de 1/2x37 cm
 Salida para flexo c/ soporte integrado
 Flexo reforzado cromado 1,50-2,0 m.
 Ducha de 3 posiciones
 Acabado: Cromo

PVP: 230,00 €

121140

Grifo monomando empotrado cromo

Incluye caja registrable
 No incluye flexo ni mango de ducha

PVP: 160,00 €

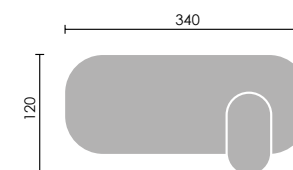

Serie **ARAS** Negro

PVD

121135 NG

Conjunto monomando empotrado de 2 vías

Caja registrable
 Rociador antical acero SS304 de 250 mm
 Brazo de ducha de 1/2x37 cm
 Salida para flexo con soporte integrado
 Flexo 1,7 PVC NEGRO
 Ducha de 5 posiciones
 Acabado: Negro mate

PVP: 295,00 €

121140NG

Grifo monomando empotrado negro mate

Incluye caja registrable
 No incluye flexo ni mango de ducha

PVP: 185,00 €

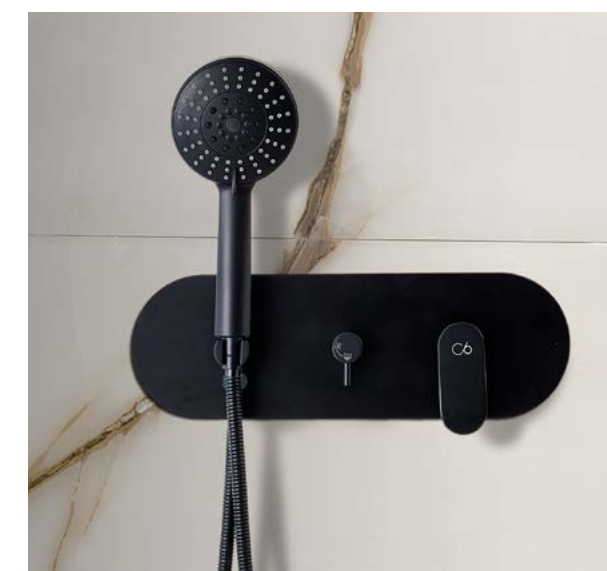
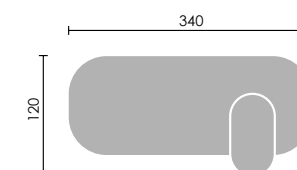



Serie **ARAS** Oro

PVD

121135OR

Conjunto monomando empotrado de 2 vías

- Caja registrable
- Rociador antical acero SS304 de 250 mm
- Brazo de ducha de 1/2x37 cm
- Salida para flexo con soporte integrado
- Flexo 1,7 PVC ORO
- Ducha de 5 posiciones
- Acabado: Oro

PVP: 345,00 €

121140OR

Grifo monomando empotrado oro cepillado

- Incluye caja registrable
- No incluye flexo ni mango de ducha

PVP: 194,00 €

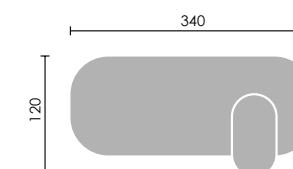

Serie **CUBE**



121611

Conjunto termostático empotrado de 2 vías

Rociador antical acero de 200x200 mm
 Brazo de ducha de 1/2
 Codo de ducha con soporte

PVP: 310,00 €

121613

Grifo termostático empotrado

PVP: 170,00 €

Cuerpo en caja empotrable

Profundidad: 63 mm



Serie **CUBE** Negro

PVD



121611NG

Conjunto termostático empotrado de 2 vías

Rociador antical acero de 200x200 mm
 Brazo de ducha de 1/2
 Codo de ducha con soporte

PVP: 375,00 €

121613

Grifo termostático empotrado

PVP: 210,00 €

Cuerpo en caja empotrable

Profundidad: 63 mm



Serie **BOL**

121610

Termostático empotrado de 2 vías

Rociador antical acero de 200 mm
 Brazo de ducha de 1/2x37 cm
 Codo de ducha con soporte

PVP: 290,00 €

121612

Grifo termostático empotrado

PVP: 165,00 €

Cuerpo en caja empotrable

Profundidad: 63 mm





Serie **KRABI**

121615

Conjunto Termostático Empotrado 2 VIAS

Rociador antical acero SS304 de 250 mm
Grifo termostático empotrado de 2 vías
Caja registrable
Brazo de ducha de 1/2x37 cm
Salida para flexo c/ soporte integrado
Flexo reforzado cromado 1,50-2,0 m.
Ducha de 3 posiciones
Acabado: Cromo

PVP: 270,00 €

121614

Grifo Termostático empotrado

Acabado cromo
Incluye caja registrable
No incluye flexo ni mango de ducha

PVP: 155,00 €

Cuerpo en caja empotrable

Profundidad: 63 mm



Serie **KRABI** Negro

PVD

121615NG

Conjunto Termostático Empotrado 2 VIAS

Rociador antical acero SS304 de 250 mm
 Grifo termostático empotrado de 2 vías
 Caja registrable
 Brazo de ducha de 1/2x37 cm
 Salida para flexo c/ soporte integrado
 Flexo reforzado cromado 1,70 m. PVC
 Ducha de 3 posiciones
 Acabado: Negro

PVP: 330,00 €

121614NG

Grifo Termostático empotrado

Acabado Negro
 Incluye caja registrable
 No incluye flexo ni mango de ducha

PVP: 175,00 €

Cuerpo en caja empotrable

Profundidad: 63 mm



Serie **KRABI** Oro

PVD

121615OR

Conjunto Termostático Empotrado 2 VIAS

Rociador antical acero SS304 de 250 mm
 Grifo termostático empotrado de 2 vías
 Caja registrable
 Brazo de ducha de 1/2x37 cm
 Salida para flexo c/ soporte integrado
 Flexo 1,7 PVC ORO
 Ducha de 3 posiciones
 Acabado: Oro Cepillado

PVP: 330,00 €

121614NG

Grifo Termostático empotrado

Acabado Oro Cepillado
 Incluye caja registrable
 No incluye flexo ni mango de ducha

PVP: 175,00 €

Cuerpo en caja empotrable

Profundidad: 63 mm



Serie **KRABI** Rosa

PVD

121615RC

Conjunto Termostático Empotrado 2 VIAS

Rociador antical acero SS304 de 250 mm
 Grifo termostático empotrado de 2 vías
 Caja registrable
 Brazo de ducha de 1/2x37 cm
 Salida para flexo c/ soporte integrado
 Flexo 1,7 PVC ROSA
 Ducha de 3 posiciones
 Acabado: Rosa Cepillado

PVP: 330,00 €

121614RC

Grifo Termostático empotrado

Acabado Rosa Cepillado
 Incluye caja registrable
 No incluye flexo ni mango de ducha

PVP: 175,00 €

Cuerpo en caja empotrable

Profundidad: 63 mm



Serie **KRABI** Gris metal PVD



121615GM

Conjunto Termostático Empotrado 2 VIAS

Rociador antical acero SS304 de 250 mm
 Grifo termostático empotrado de 2 vías
 Caja registrable
 Brazo de ducha de 1/2x37 cm
 Salida para flexo c/ soporte integrado
 Flexo 1,7 PVC GRIS
 Ducha de 3 posiciones
 Acabado: Gris metal

PVP: 330,00 €

121614GM

Grifo Termostático empotrado

Acabado Rosa Cepillado
 Incluye caja registrable
 No incluye flexo ni mango de ducha

PVP: 175,00 €

Cuerpo en caja empotrable

Profundidad: 63 mm



Grifería de COCINA

■ Serie 121112	228 / 229	
■ Serie TAO	230 / 231	
■ Serie OKI	232 / 233	
■ Serie KÍOS	234 / 235	
■ Serie KÍOS Gris metal	236 / 237	
■ Serie YDRA	238 / 239	
■ Serie ELBA	240 / 241	● ○
■ Serie ELBA bicolor	242 / 243	● ○
■ Serie QALA	244 / 245	● ○
■ Serie QALA bicolor	246 / 247	● ○
■ Serie KU	248 / 249	
■ Serie 121113	250 / 251	
■ Serie CORVO	252 / 253	● ○
■ Serie 121117	254 / 255	
■ Serie 121115	256 / 257	
■ Serie 121105	258 / 259	
■ Serie 121805	260 / 261	
■ Serie NEW Osmosis	262 / 263	● ●
■ Serie 121704 Osmosis	264 / 265	
■ Serie 121708 Osmosis	266 / 267	
■ Serie CISNE	268	
■ Serie ALFA	269 / 273	
■ Serie CLASSIC	274 / 277	
■ Serie BASIC	278 / 279	

Serie 121112



121112

Monomando fregadero flexible
/ Sink mixer

Acabado cromo
Cartucho 35 mm.

PVP: 160,00 €

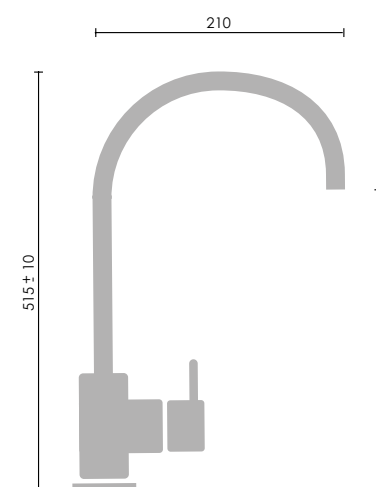

Serie TAO



121116

Monomando fregadero flexible / Sink mixer

Acabado cromo
Cartucho 35 mm.

PVP: 130,00 €

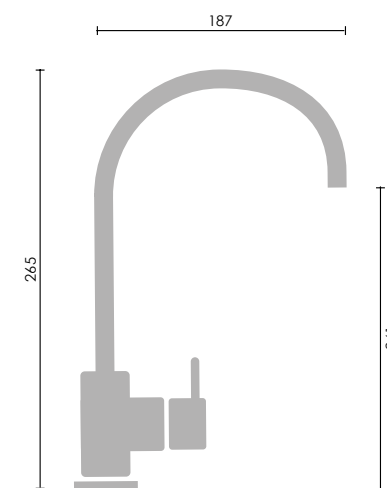

Serie OKI



121016

Monomando fregadero / Sink mixer

Acabado cromo
Cartucho 35 mm.

PVP: 117,00 €

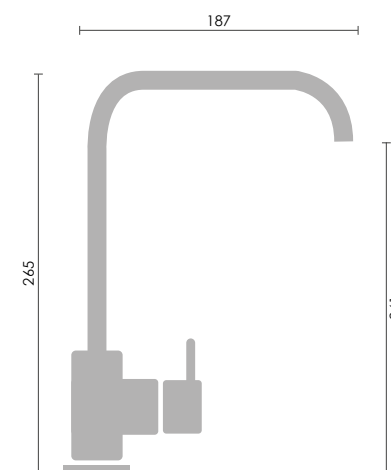

Serie **KÍOS**



121035

Monomando fregadero / Sink mixer

Acabado cromo
Cartucho 35 mm.

PVP: 109,00 €

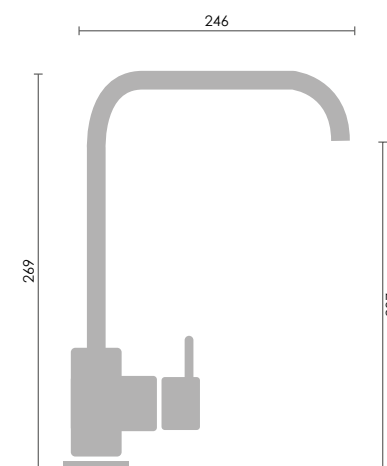

Serie **BARI** Gris metal

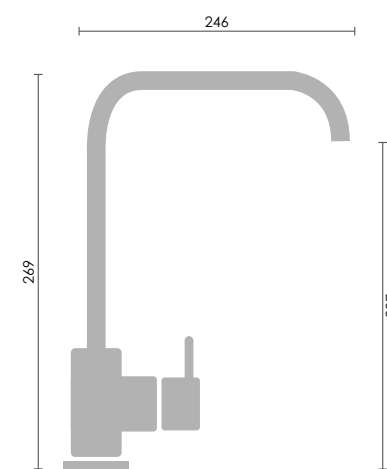

121649GM

Monomando fregadero / Sink mixer

Acabado gris metal
Cartucho 35 mm.

PVP: 118,00 €

121649

Monomando fregadero / Sink mixer

Acabado cromo
Cartucho 35 mm.

PVP: 89,00 €



Serie **YDRA**



121205

Monomando fregadero / Sink mixer

Acabado cromo
Cartucho 35 mm.
Apertura en frío

PVP: 82,00 €

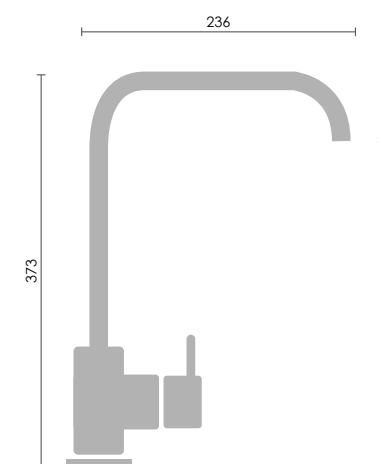

Serie ELBA



121019NG

Monomando fregadero / Sink mixer

Acabado negro mate
Cartucho 35 mm.

PVP: 98,00 €

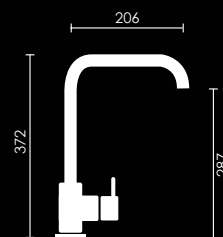

121019

Monomando fregadero / Sink mixer

Acabado cromo
Cartucho 35 mm.

PVP: 88,00 €

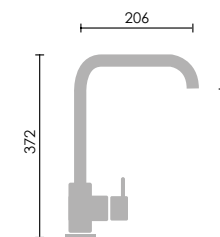

121019BL

Monomando fregadero / Sink mixer

Acabado blanco
Cartucho 35 mm.

PVP: 98,00 €

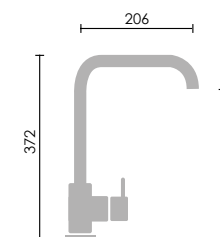

121019IN

Monomando fregadero / Sink mixer

Acabado cromo inox.
Cartucho 35 mm.

PVP: 102,00 €

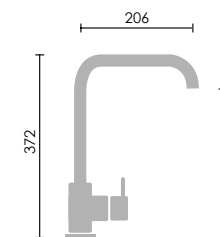

Serie **ELBA** Bicolor



121019 CN

Monomando fregadero / Sink mixer

Acabado cromo - negro mate
Cartucho 35 mm

PVP: 93,00 €

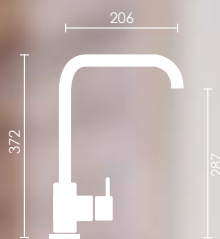

121019 CB

Monomando fregadero / Sink mixer

Acabado cromo - blanco
Cartucho 35 mm

PVP: 93,00 €

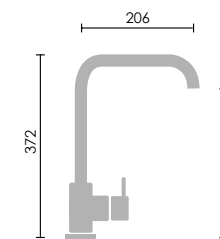

Serie QALA

121020IN

Monomando fregadero / Sink mixer

Acabado acero inox.
Cartucho 35 mm.

PVP: 102,00 €

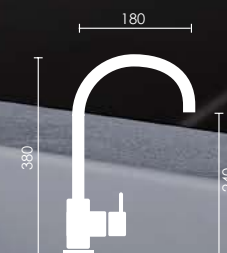

121020NG

Monomando fregadero / Sink mixer

Acabado cromo negro mate
Cartucho 35 mm

PVP: 98,00 €

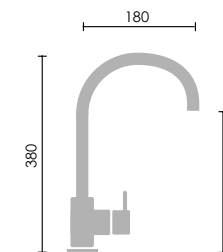

121020BL

Monomando fregadero / Sink mixer

Acabado blanco
Cartucho 35 mm

PVP: 98,00 €

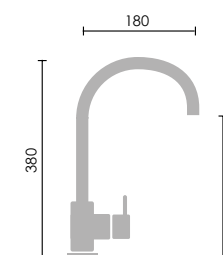

121020

Monomando fregadero / Sink mixer

Acabado cromo
Cartucho 35 mm

PVP: 88,00 €

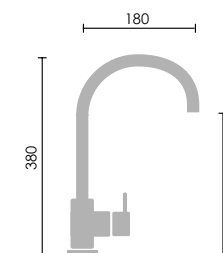

Serie **QALA** Bicolor



121020 CB

Monomando fregadero / Sink mixer

Acabado cromo - blanco
Cartucho 35 mm

PVP: 93,00 €

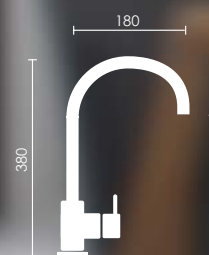

121020 CN

Monomando fregadero / Sink mixer

Acabado cromo - negro mate
Cartucho 35 mm

PVP: 93,00 €

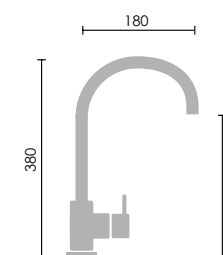

Serie **KU**



121005

Monomando fregadero / Sink mixer

Acabado cromo
Cartucho 35 mm.

PVP: 110,00 €

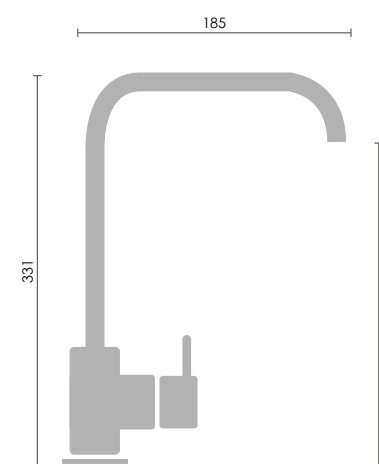

Serie 121113



121113

Monomando fregadero extraible /
Sink mixer

Acabado cromo
Cartucho 35 mm.
Flexo extraible 1,50 m

PVP: 115,00 €

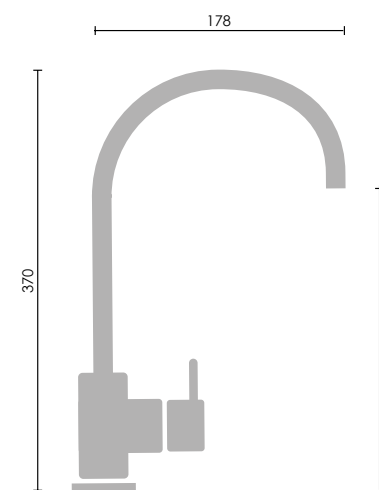

Serie CORVO



252

clausyath

121018

Monomando fregadero CORVO B / Sink mixer

Acabado blanco-cromo
Cartucho 35 mm.

PVP: 67,00 €

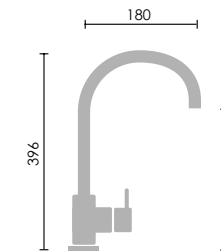

Crifería de
COCINA

121017

Monomando fregadero CORVO N / Sink mixer

Acabado negro-cromo
Cartucho 35 mm.

PVP: 67,00 €

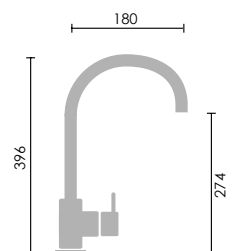

253

Serie 121117



121117

Monomando fregadero tubo / Sink mixer

Acabado cromo
Cartucho 35 mm.
Aireador H22 mm

PVP: 71,00 €

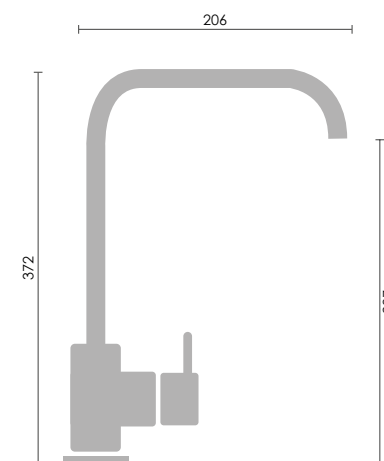

Serie 121115



121115

Monomando fregadero recto / Sink mixer

Acabado cromo
Cartucho 35 mm.
Aireador H22 mm

PVP: 79,00 €

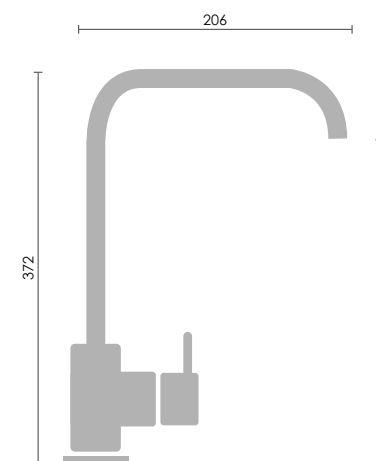

Serie **121105**



121105

Monomando fregadero curvo /

Sink mixer

Acabado cromo
Cartucho 35 mm
Aireador H22 mm

PVP: 72,00 €

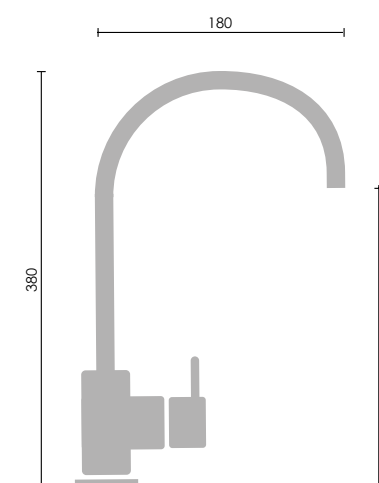

Serie **121805**



121805

Monomando fregadero KOBA / Sink mixer

Acabado cromo
Cartucho 35 mm
Aireador H22 mm

PVP: 57,00 €

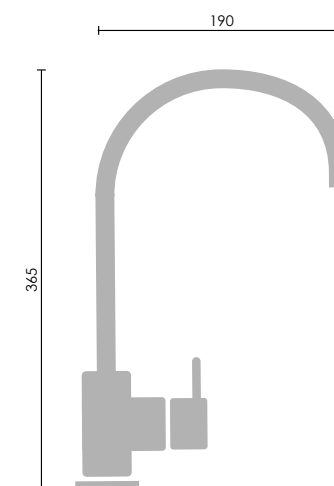

Serie **NEW** Osmosis

121709

Monomando fregadero new OSMOSIS / Sink mixer

Acabado cromo
Cartucho 35 mm.
Aireador H22 mm

PVP: 146,00 €

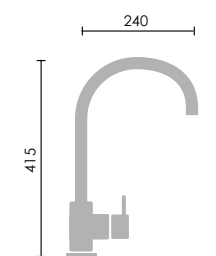

121709 NG

Monomando fregadero new OSMOSIS / Sink mixer

Acabado negro
Cartucho 35 mm.
Aireador H22 mm

PVP: 152,00 €

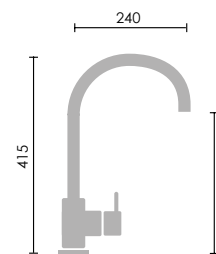

121709 OR

Monomando fregadero new OSMOSIS / Sink mixer

Acabado oro
Cartucho 35 mm.
Aireador H22 mm

PVP: 168,00 €

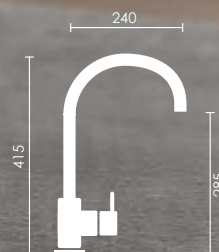

Serie **121704** Osmosis



121704

Monomando fregadero OSMOSIS / Sink mixer

2 posiciones:

- Agua sanitaria
- Filtros (osmosis)

Acabado cromo
Cartucho 35 mm
Aireador M24 mm
Aireador osmosis M18 mm

PVP: 131,00 €

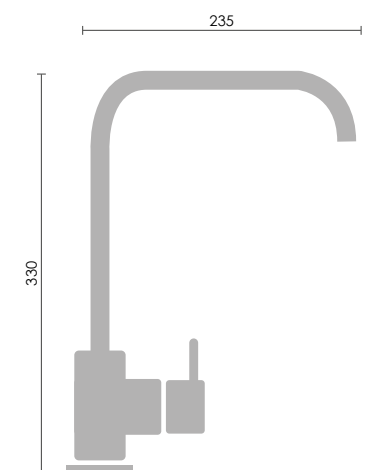

Serie **121708** Osmosis



121708

Monomando fregadero OSMOSIS / Sink mixer

2 posiciones:

- Agua sanitaria
- Filtros (osmosis)

Acabado cromo
 Cartucho 35 mm
 Aireador M24 mm
 Aireador osmosis M18 mm

PVP: 155,00 €

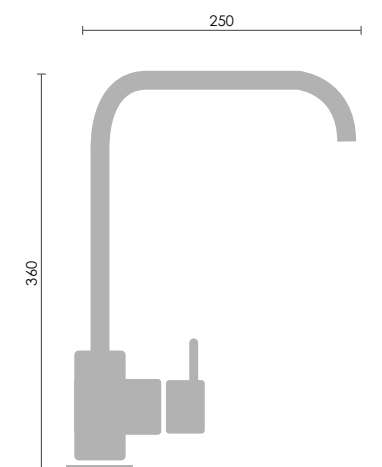

Serie CISNE

Serie ALFA

121123

Monomando fregadero CISNE / Sink mixer

Acabado cromo
Cartucho 40 mm.
Aireador H22 mm

PVP: 44,00 €

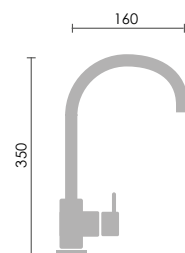

121305

Monomando fregadero caño fundido / Sink mixer

Acabado cromo
Cartucho 40 mm.
Aireador M24 mm

PVP: 79,00 €

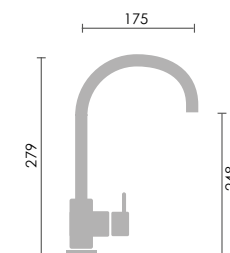

121306

Monomando fregadero caño conformado / Sink mixer

Acabado cromo
Cartucho 40 mm.
Aireador M24 mm

PVP: 42,00 €

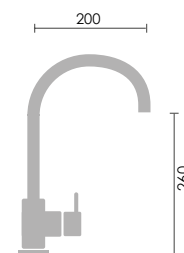

Serie ALFA



121316
Monomando fregadero / Sink mixer
 Acabado cromo
 Cartucho 40 mm.
 PVP: 44,00 €



121307
Monomando fregadero caño giratorio / sink mixer

Acabado cromo
 Cartucho 40 mm.
 Aireador M24 mm.

PVP: 44,00 €

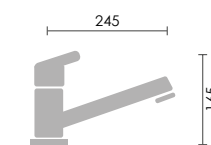

121310
Monomando fregadero extraíble alto / Removable sink mixer

Flexo extraíble 1,50 m
 Ducha ABS 2 posiciones
 Acabado cromo
 Cartucho 40 mm.

PVP: 84,00 €

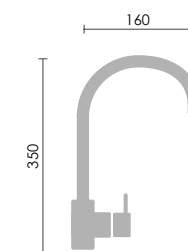

121311
Monomando fregadero extraíble bajo / Removable sink mixer

Flexo extraíble 1,50 m
 Ducha ABS 2 posiciones
 Acabado cromo
 Cartucho 40 mm.

PVP: 75,00 €

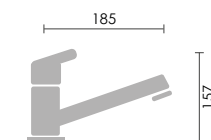

Serie ALFA



121314

Monomando fregadero pared caño alto (13x17) / Wall sink mixer

Acabado cromo
Cartucho 40 mm.

PVP: 65,00 €

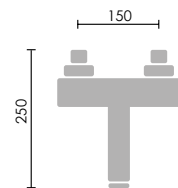

121315

Monomando fregadero pared caño conformado (9x13) / Wall sink mixer

Acabado cromo
Cartucho 40 mm.
Aireador M24 mm.

PVP: 65,00 €

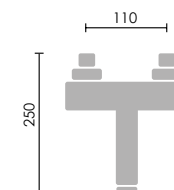

121308

Monomando fregadero pared caño fundido (13x17) / Wall sink mixer

Acabado cromo
Cartucho 40 mm.
Aireador M24 mm.

PVP: 80,00 €

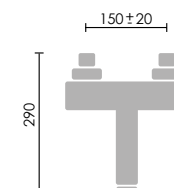

121309

Monomando fregadero pared caño bajo (13x17) / Wall sink mixer

Acabado cromo
Cartucho 40 mm.
Aireador M24 mm.

PVP: 68,00 €

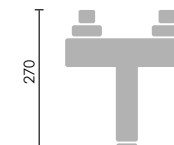

Serie CLASSIC



121407

Batería fregadero pared (13x17) / Wall sink mixer

Acabado cromo
Montura cerámica 1/4 v
Aireador H22 mm.

PVP: 95,00 €

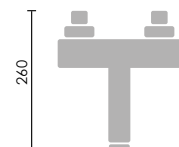

121408

Grifo fregadero giratorio / Wall mounted tap

Acabado cromo
Montura cerámica 1/4 v
Aireador H22 mm.

PVP: 42,00 €



121405

Monobloc fregadero caño giratorio / Mono sink mixer

Acabado cromo
Montura cerámica 1/4 v
Aireador H22 mm.

PVP: 71,00 €

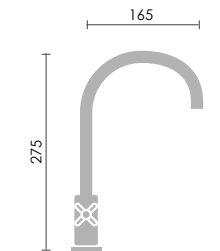

121406

Monobloc fregadero caño giratorio / Mono sink mixer

Acabado cromo
Montura cerámica 1/4 v
Aireador H22 mm.

PVP: 118,00 €

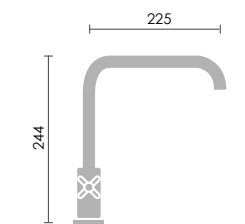

La serie classic se puede servir con montura convencional.

Serie CLASSIC

121416
Monobloc fregadero caño giratorio
 / Mono sink mixer

Acabado bronce
 Montura cerámica 1/4 v
 Aireador H22 mm.

PVP: 135,00 €

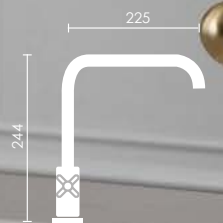

121415
Monobloc fregadero / Mono sink
 mixer

Acabado bronce
 Montura cerámica 1/4 v
 Aireador H22 mm.

PVP: 87,00 €

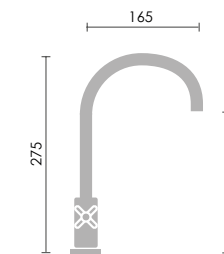

121417
Batería fregadero pared (13x17) /
 Wall sink mixer

Acabado bronce
 Montura cerámica 1/4 v
 Aireador H22 mm.

PVP: 115,00 €

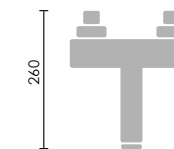

La serie classic se puede servir con montura convencional.

Serie BASIC

121507

Grifo fregadero 1/2 fijo (14 cm. 1/2) /
Wall mounted tap

Acabado cromo
Montura cerámica 1/4 v

PVP: 21,00 €

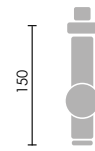

121510

Grifo lavavajillas / Mixer for washing machine

Acabado cromo
Montura cerámica 1/4 v

PVP: 22,00 €

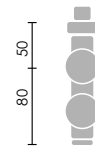

121509

Grifo lavavajillas doble / Mixer for washing machine

Acabado cromo
Montura cerámica 1/4 v

PVP: 22,00 €

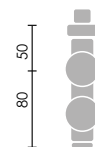

Batería fregadero pared / Wall mounted kitchen mixer

Acabado cromo
Montura cerámica 1/4 v

121504 (13x17)

PVP: 54,00 €

121505 (9x13)

PVP: 53,00 €

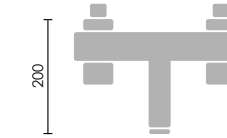

121506

Grifo fregadero giratorio / Wall mounted tap

Acabado cromo
Montura cerámica 1/4 v

PVP: 23,70 €



121508

Grifo lavadora normal / Mixer for washing machine

Acabado cromo
Montura cerámica 1/4 v

PVP: 10,40 €



Grifería **ESPECIAL**

■ Serie SWAN	282 / 283
■ Serie WEI	284 / 285
■ BIDÉ Inodoro	286 / 292
■ Monomando 1 agua	293
■ Grifería termostática	294 / 295
■ Grifería medical	296 / 297
■ Grifería temporizada	298 / 299



Serie **SWAN**



121226

**Grifería de pie para bañera /
Sink mixer**

Monomando
Flexo cromado 1,7 m
Ducha Minimalista 1 posición
Acabado cromo
Cartucho 35 mm

PVP: 395,00 €

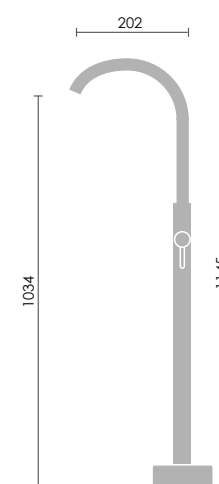

Serie **WEI**



121336

Grifería de pie para bañera /
Sink mixer

Monomando
Flexo cromado 1,7 m
Ducha Minimalista 1 posición
Acabado cromo
Cartucho 35 mm

PVP: 470,00 €

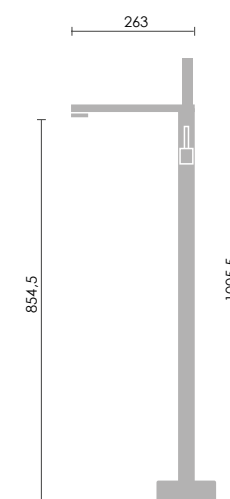

Serie **BIDÉ** Inodoro

Conjunto sustitución de bidé

121108

Conjunto sustitución bidé 2 aguas /
Supply bidet

Flexo cromado 1,20 antitorsión
Acabado cromo
Cartucho 35 mm.

PVP: 95,00 €

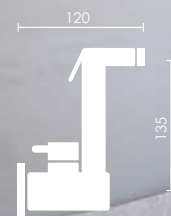

Serie **BIDÉ** Inodoro negro



121108 NG

Conjunto sustitución bidé 2 aguas /
Supply bidet

Flexo 1,20 PVC negro
Acabado negro mate
Cartucho 35 mm.

PVP: 118,00 €

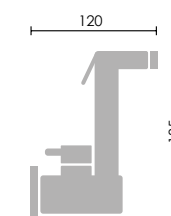



121108OR

**Conjunto sustitución bidé 2 aguas /
Supply bidet**

Flexo cromado 1,20 oro cepillado
Acabado oro cepillado
Cartucho 35 mm.

PVP: 135,00 €

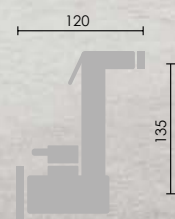

121108GM

**Conjunto sustitución bidé 2 aguas /
Supply bidet**

Flexo 1,20 PVC
Acabado gris metal
Cartucho 35 mm.

PVP: 135,00 €

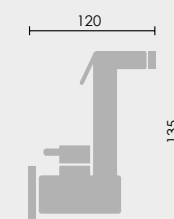

Serie **BIDÉ** Inodoro negro cuadrado



121011 NG

Conjunto sustitución bidé 2 aguas / Supply bidet

Flexo 1,20 PVC negro
Acabado negro mate
Cartucho 35 mm.

PVP: 141,00 €

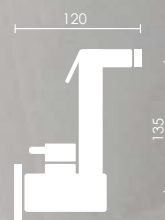

Serie **BIDÉ** Inodoro cuadrado



121011

Conjunto sustitución bidé 2 aguas / Supply bidet

Flexo cromado 1,20 antitorsi3n
Acabado cromo
Cartucho 35 mm.

PVP: 115,00 €

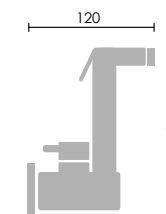

Serie **BIDÉ** Inodoro



Soporte incorporado en el cuerpo de la grifería

121124

Conjunto bidé inodoro 1 agua /
Supply bidet

Acabado cromo
Montura cerámica 1/4 v

PVP: 57,00 €

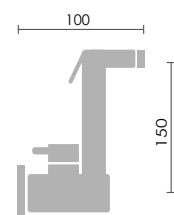

Monomando de 1 agua

121503M

Monomando fregadero vertical /
Basin mixer

1 agua
Acabado cromo
Cartucho 25 mm.

PVP: 25,80 €

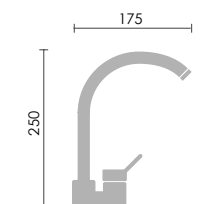

121501M

Monomando lavabo / Basin mixer

1 agua
Acabado cromo
Cartucho 25 mm.

PVP: 23,80 €

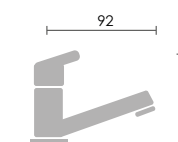

121507M

Monomando fregadero pared /
Basin mixer

13 cm. 1 agua
Acabado cromo
Cartucho 25 mm.

PVP: 22,80 €

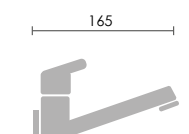

Grifería termostática

Bol
121601

Termostático de baño para ducha /
Thermostatic bath shower mixer

Flexo, mango de ducha y soporte
Acabado cromo

PVP: 135,00 €



Cube
121604

Termostático de baño para ducha /
Thermostatic bath shower mixer

Flexo, mango de ducha y soporte
Acabado cromo

PVP: 165,00 €



Bol
121602

Termostático para ducha /
Thermostatic shower mixer

Flexo, mango de ducha y soporte
Acabado cromo

PVP: 108,00 €



Cube
121605

Termostático para ducha /
Thermostatic shower mixer

Flexo, mango de ducha y soporte
Acabado cromo

PVP: 140,00 €



Bol
121603

Termostático para ducha /
Thermostatic shower mixer

Salida superior 3/4
Acabado cromo

PVP: 115,00 €



Cube
121606

Termostático para ducha /
Thermostatic shower mixer

Salida superior 3/4
Acabado cromo

PVP: 145,00 €



Grifería medical

121701

Monomando lavabo
Palanca gerontológica / Basin mixer

Acabado cromo
Cartucho 40 mm

PVP: 52,00 €

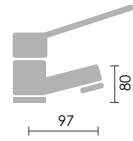

121702

Monomando fregadero
Palanca gerontológica
Caño giratorio bajo /

Sink mixer with tilted rotating spout

Acabado cromo
Cartucho 40 mm

PVP: 67,00 €

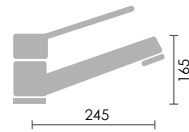

121703

Monomando fregadero mural
Palanca gerontológica / Sink mixer

Acabado cromo
Cartucho 40 mm

PVP: 85,00 €

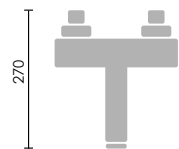

Grifería medical de 1 agua

121707

Grifería pared medical 1/2 /
Wall tap

Caño giratorio 1 agua
Cromo
Montura cerámica 1/4 v

PVP: 78,00 €



121706

Grifería pared medical 1/2 /
Wall tap

Caño fijo 1 agua
Cromo
Montura cerámica 1/4 v

PVP: 60,00 €



Grifería temporizada

121711

Grifo lavabo 1/2 / Sink faucet

Acabado cromo

PVP: 40,00 €

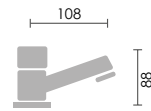

121715

Ducha temporizada empotrada / Built-in timer shower mixer

Acabado cromo

PVP: 56,00 €

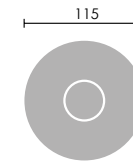

121712

Grifo lavabo 1/2 / Sink faucet

Acabado cromo

PVP: 58,00 €

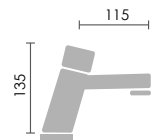

121714

Grifo de urinario 1/2 / Urinary tap 1/2

Acabado cromo

PVP: 36,00 €

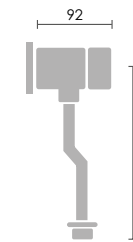

121713

Grifo frontal 1/2 / Sink faucet

Acabado cromo

PVP: 38,00 €

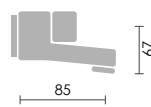

COMPLEMENTOS

■ JABONERAS	302 / 309	● ● ● ○
■ ASIENTOS	310 / 311	
■ ASIDEROS	312 / 313	● ● ● ○
■ PORTARROLLO	314 / 315	● ● ● ○
■ TOALLEROS	316 / 139	● ● ● ○
■ PERCHA	320 / 321	● ● ● ○
■ ROCIADORES	322 / 325	● ● ● ○
■ BRAZOS DE DUCHA	326 / 328	● ● ● ○
■ CODOS DE DUCHA	329 / 330	● ● ● ○
■ SIFONES	331 / 333	● ● ● ○
■ BRAZOS DESLIZANTES	334 / 335	
■ MANGOS DE DUCHA	336 / 340	● ● ○
■ SOPORTES	341	
■ FLEXOS	342 / 343	● ● ○
■ VÁLVULAS CLIC-CLAC	344 / 345	● ● ● ○

JABONERAS

123706

Jabonera para barra de ducha

Para diámetro de barra desde 22 a 25 cm
Acero inox.
Cromo brillo

PVP: 40,00 €

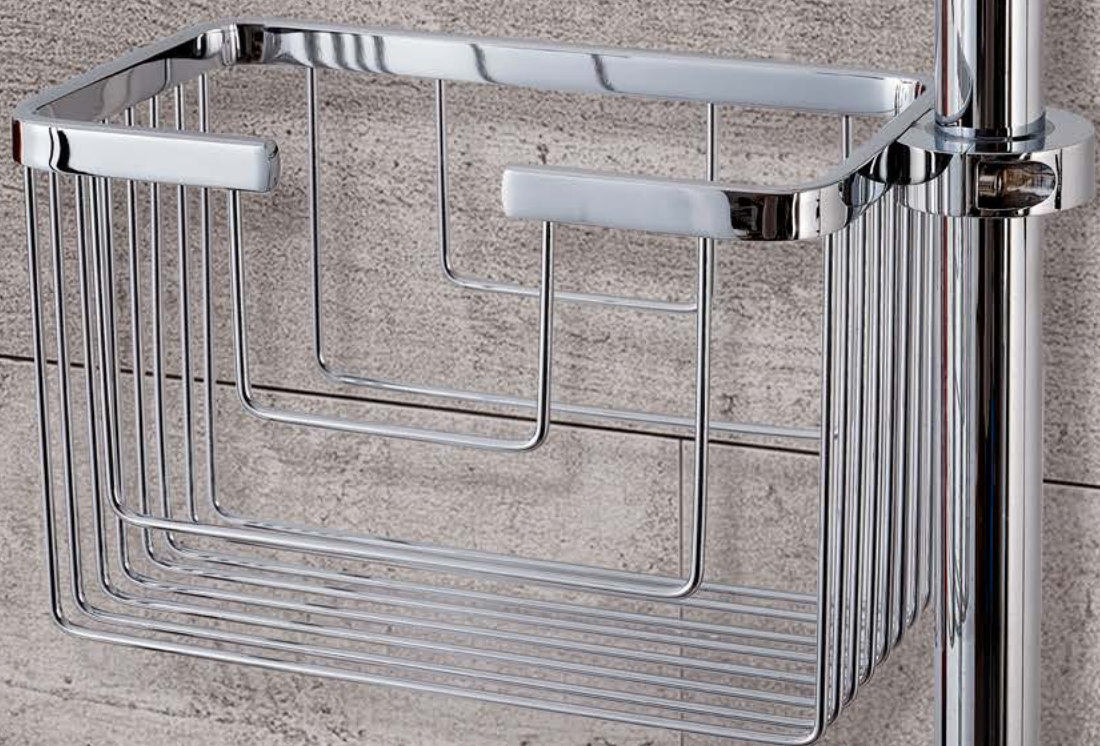
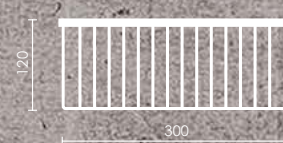
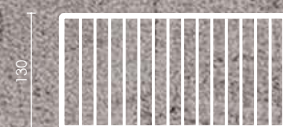

123702

Jabonera de rincón

Altura 14 cm
Acero inox.
Cromo brillo

PVP: 32,00 €

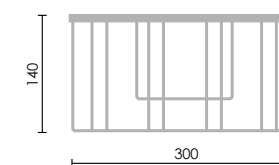
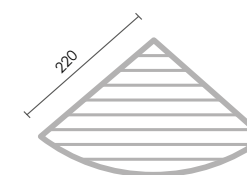

123703

Jabonera de rincón

Altura 8 cm
Acero inox.
Cromo brillo

PVP: 29,00 €

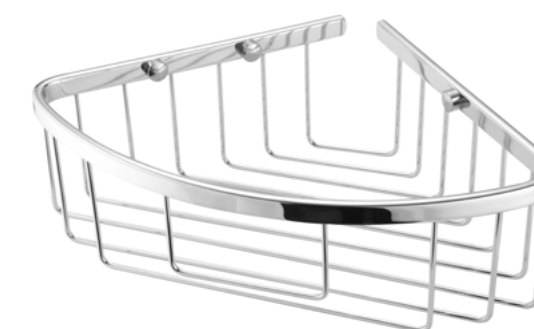
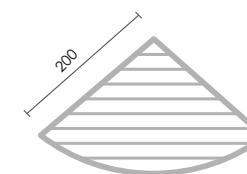

JABONERAS

123701

Jabonera para grifería

Acero inox.
Cromo brillo

PVP: 43,00 €

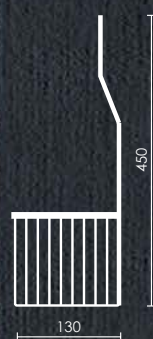
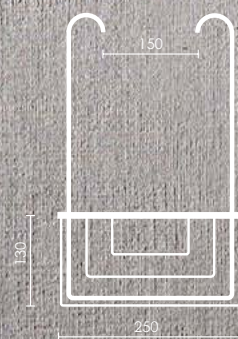

123708

Jabonera para grifería

Acero inox.
Cromo brillo

PVP: 38,00 €

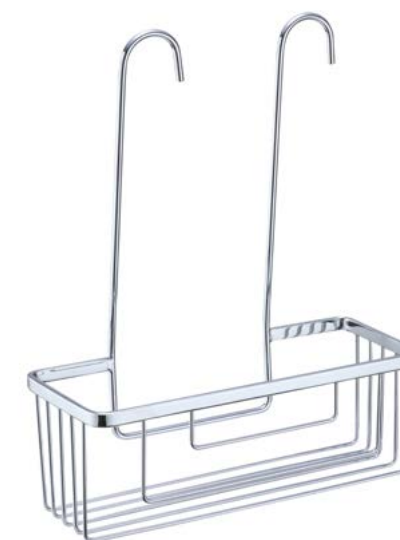
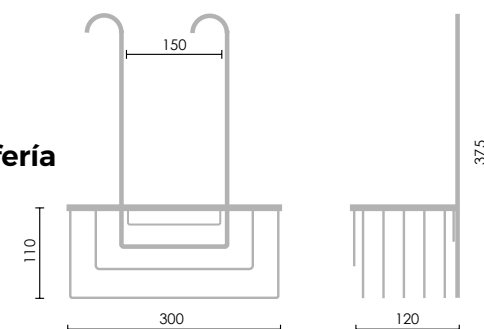

123708 NG

Jabonera para grifería

Acero inox.
Negro mate

PVP: 43,00 €

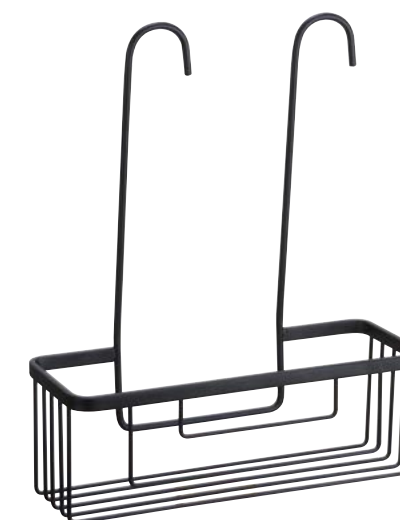
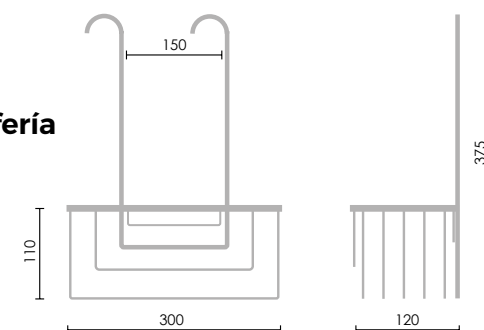

JABONERAS

123708 BL

Jabonera para grifería

Acero inox.
Blanco mate

PVP: 43,00 €

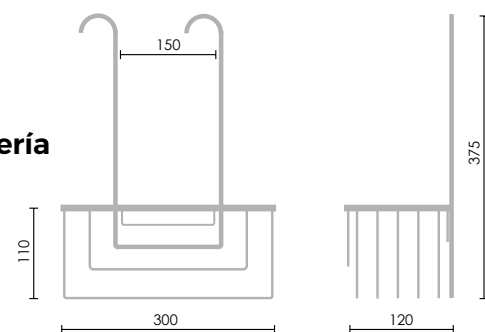

123708OC

Jabonera para grifería

Acero inox. SS304
Oro cepillado

PVP: 46,00 €

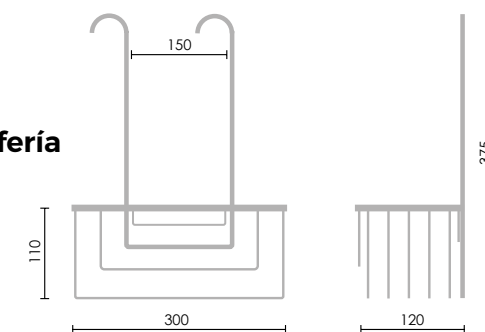

123708RC

Jabonera para grifería

Acero inox. SS304
Rosa cepillado

PVP: 46,00 €

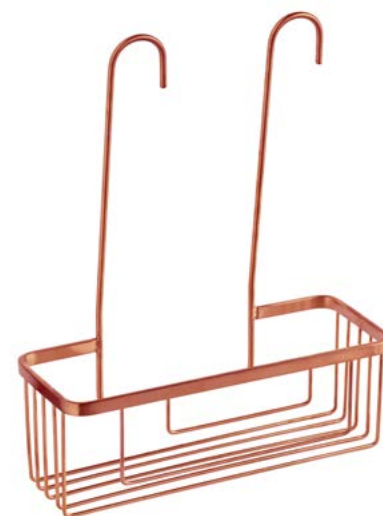
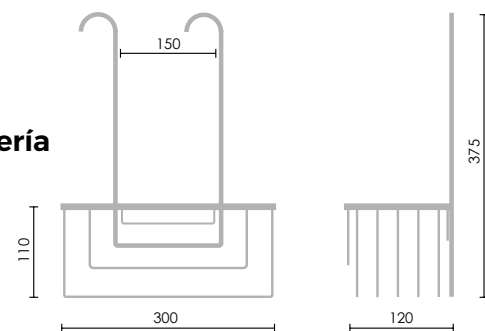

123708GM

Jabonera para grifería

Acero inox. SS304
Gris metal

PVP: 46,00 €

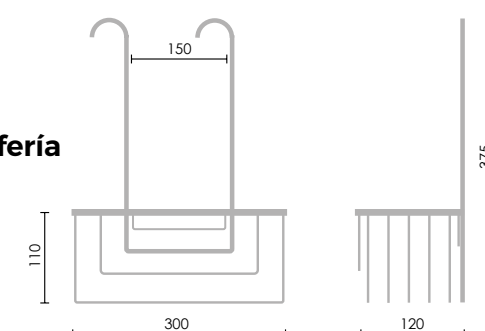

JABONERAS

123705

Jabonera doble

Acero inox.
Cromo brillo

PVP: 68,00 €

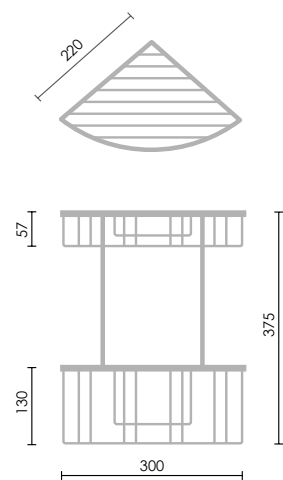

123704

Jabonera rectangular

Altura 12 cm
Acero inox.
Cromo brillo

PVP: 32,00 €

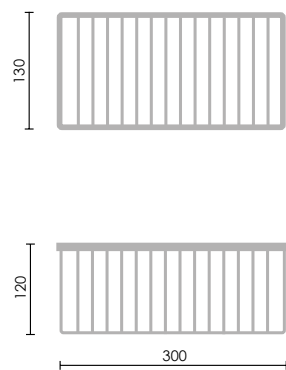

123707

Jabonera recta de rincón

Altura 16 mm
Latón
Cromo brillo

PVP: 45,00 €

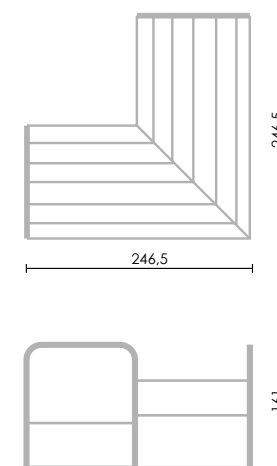

ASIENTOS



123415

Banqueta con patas

Soporta 110 kg
Patas regulables en altura de 45 a 57 cm

PVP: 46,00 €

123412

Asiento plegable

Peso máximo 150 kg
Madera de Teka
Aluminio anodizado

PVP: 88,00 €



123410

Asiento plegable

Soporta 200 kg de forma segura
Patas de acero con recubrimientos Epoxi
Plataforma de sujeción a la pared de aluminio
Asiento ABS

PVP: 94,00 €

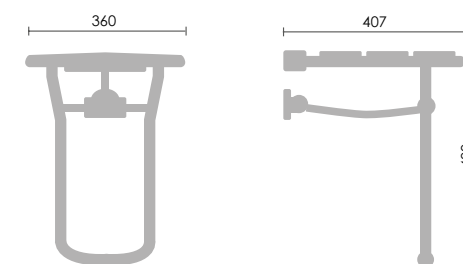

ASIDEROS

Asidero de baño reforzado

123405 25 cm PVP: 22,00 €

123406 30 cm PVP: 23,00 €

123407 40 cm PVP: 26,00 €



Asidero de baño reforzado

Negro mate

123406NG 30 cm PVP: 26,00 €



Asidero de baño reforzado

Oro cepillado

123406OR 30 cm PVP: 29,00 €



Asidero de baño reforzado

Rosa cepillado

123406RC 30 cm PVP: 29,00 €



Asidero de baño reforzado

Gris metal

123406GM 30 cm PVP: 29,00 €



Asidero de baño antideslizante

123416 30 cm PVP: 25,00 €

123417 40 cm PVP: 28,00 €



Asidero de baño antideslizante

Negro mate

123416NG 30 cm PVP: 34,00 €



Asidero de baño antideslizante

Oro cepillado

123416OR 30 cm PVP: 34,00 €



Asidero de baño antideslizante

Rosa cepillado

123416RC 30 cm PVP: 34,00 €



Asidero de baño antideslizante

Gris metal

123416GM 30 cm PVP: 34,00 €



PORTARROLLO

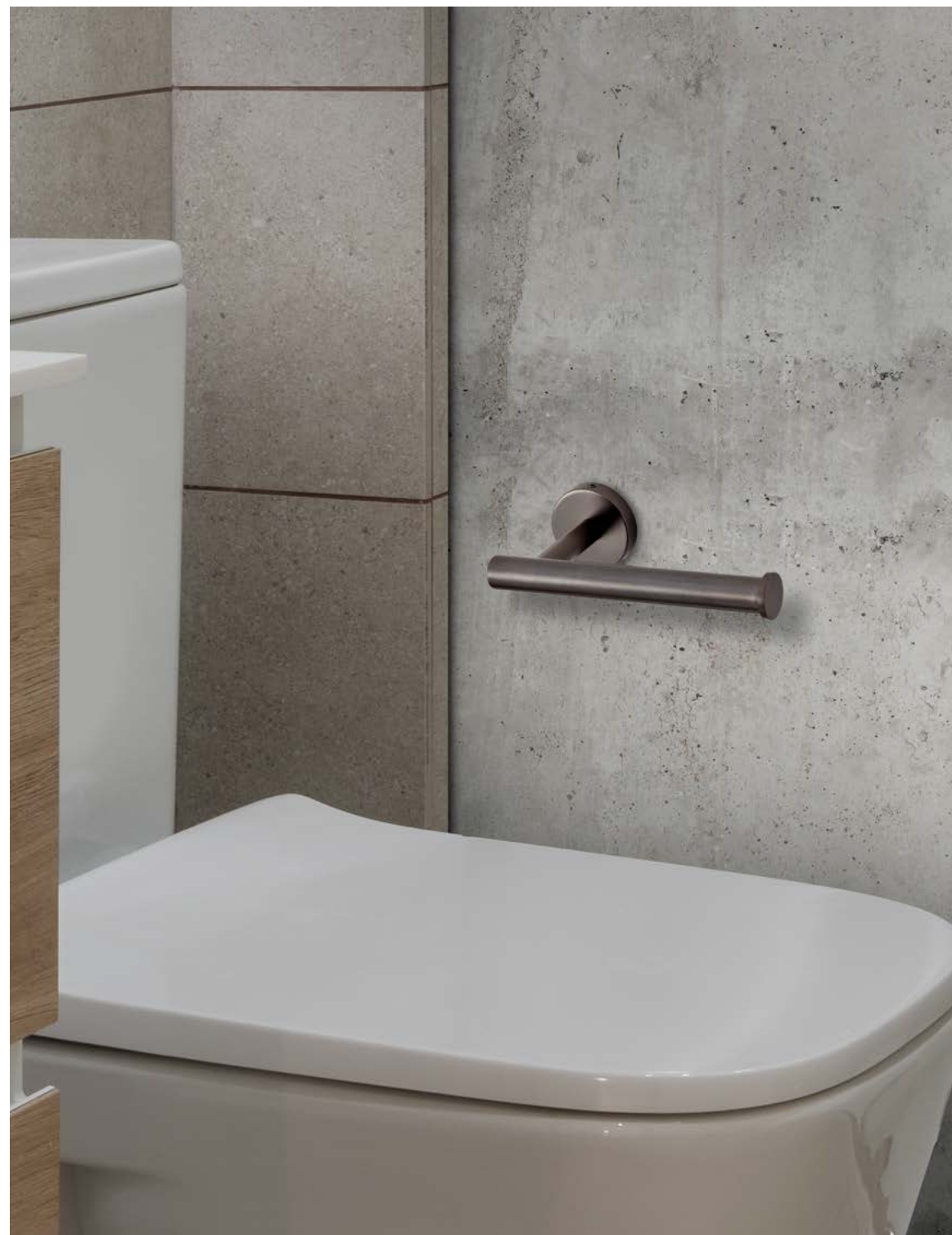

123423GM

Portarrollos / Toilet paper holder

Acabado gris metal
Acero SS304

PVP: 22,00 €



123423

Portarrollos / Toilet paper holder

Acabado CROMO
Acero SS304

PVP: 17,00 €



123423NG

Portarrollos / Toilet paper holder

Acabado NEGRO MATE
Acero SS304

PVP: 19,00 €



123423OR

Portarrollos / Toilet paper holder

Acabado ORO CEPILLADO
Acero SS304

PVP: 21,00 €



123423RC

Portarrollos / Toilet paper holder

Acabado ROSA CEPILLADO
Acero SS304

PVP: 21,00 €

TOALLEROS



123424OR

Toallero de barra / Towell bar

Acabado ORO CEPILLADO
Acero SS304

PVP: 28,00 €



123423

Toallero de barra / Towell bar

Acabado CROMO
Acero SS304

PVP: 24,00 €



123423NG

Toallero de barra / Towell bar

Acabado NEGRO MATE
Acero SS304

PVP: 26,00



123423RC

Toallero de barra / Towell bar

Acabado ROSA CEPILLADO
Acero SS304

PVP: 28,00



123423GM

Toallero de barra / Towell bar

Acabado GRIS METAL
Acero SS304

PVP: 29,00

PERCHA



123425RC

Percha / Hanger

Acabado ROSA CEPILLADO
Acero SS304

PVP: 15,00 €



123425

Percha / Hanger

Acabado CROMO
Acero SS304

PVP: 12,00 €



123425NG

Percha / Hanger

Acabado NEGRO MATE
Acero SS304

PVP: 14,00 €



123425OR

Percha / Hanger

Acabado ORO CEPILLADO
Acero SS304

PVP: 15,00 €



123425GM

Percha / Hanger

Acabado GRIS METAL
Acero SS304

PVP: 16,00 €

TOALLEROS

Toallero para mueble

Acero inox. 304
Cromo brillo

123419 29 cm Cromo PVP: 24,00 €

123419NG 29 cm Negro PVP: 27,00 €



Toallero para mueble SLIM

Acero inox. 304
Cromo brillo

123422 36 cm. PVP: 18,00 €



Toallero para mueble

123420 36 cm Cromo PVP: 26,00 €

123420NG 36 cm Negro mate PVP: 29,00 €

123420BL 36 cm Blanco mate PVP: 29,00 €

123420OR 36 cm Oro PVP: 31,00 €

123420RC 36 cm Rosa PVP: 31,00 €

123420GM 36 cm Gris PVP: 31,00 €



PORTARROLLO

123418

Portarrollos para mueble

Acero inox. 304
Cromo brillo

PVP: 21,00 €



123418NG

Portarrollos para mueble

Acero inox. 304
Negro

PVP: 26,00 €



ROCIADORES

Rociador redondo 200 RAC

Acero. Anticalcáreo. Con rótula

123222 ϕ 200 mm PVP: 28,00 €

123223 ϕ 250 mm PVP: 42,00 €

123224 ϕ 300 mm PVP: 60,00 €

123225 ϕ 400 mm PVP: 94,00 €



Rociador redondo rosa

Acero. Anticalcáreo. Con rótula

123223RC ϕ 250 mm PVP: 65,00 €

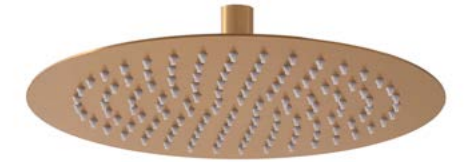

Rociador redondo negro mate

Acero. Anticalcáreo. Con rótula

123222NG ϕ 200 mm PVP: 33,00 €

123223NG ϕ 250 mm PVP: 53,00 €

123224NG ϕ 300 mm PVP: 72,00 €



Rociador redondo gris

Acero. Anticalcáreo. Con rótula

123223GM ϕ 250 mm PVP: 65,00 €



Rociador redondo blanco mate

Acero. Anticalcáreo. Con rótula

123223BL ϕ 250 mm PVP: 51,00 €



Rociador cuadrado

Acero. Anticalcáreo. Con rótula

123226 ϕ 200 mm PVP: 30,00 €

123227 ϕ 250 mm PVP: 44,00 €

123228 ϕ 300 mm PVP: 62,00 €

123229 ϕ 400 mm PVP: 96,00 €



Rociador redondo oro

Acero. Anticalcáreo. Con rótula

123223OR ϕ 250 mm PVP: 65,00 €



ROCIADORES

Rociador rectangular

Acero. Anticalcáreo. Con rótula

123233 200x250 mm PVP: 44,00 €



Rociador rectangular

Acero. Anticalcáreo. Con rótula. Negro mate

123233NG 200x250 mm PVP: 53,00 €



Rociador cuadrado negro

Acero. Anticalcáreo. Con rótula

123226NG ø 200 mm PVP: 37,00 €

123227NG ø 250 mm PVP: 55,00 €

123228NG ø 300 mm PVP: 74,00 €

123229NG ø 400 mm PVP: 103,00 €



Rociador redondo 200

ABS. Anticalcáreo. Con rótula

123204 ø 200 mm PVP: 24,00 €



Rociador cuadrado 200

ABS. Anticalcáreo. Con rótula

123203 200x200 mm PVP: 24,00 €



Rociador redondo

ABS. Anticalcáreo. Con rótula.

123232 ø 220 mm PVP: 19,00 €



Rociador redondo

ABS. Anticalcáreo. Con rótula.

123201 ø 200 mm PVP: 9,00 €



BRAZOS DE DUCHA

123208

Brazo de ducha de 1/2

PVP: 36,00 €

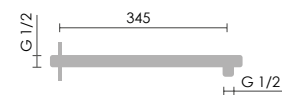

123208NG

Brazo de ducha de 1/2

PVP: 41,00 €

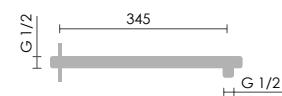

123230

Brazo de ducha de 1/2

PVP: 35,00 €

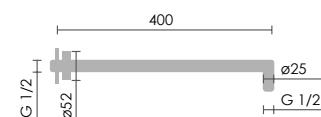

123219

Brazo de ducha fundido de 1/2x15 16cm

PVP: 10,00 €

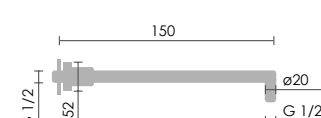

123221

Brazo de ducha de 1/2x30

PVP: 18,00 €

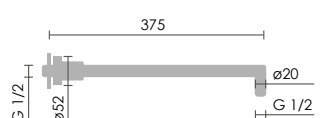

123207

Brazo de ducha de 1/2

PVP: 28,00 €



123207NG

Brazo de ducha de 1/2

PVP: 35,00 €



123207OR

Brazo de ducha de 1/2

PVP: 36,00 €



123207GM

Brazo de ducha de 1/2

PVP: 38,00 €

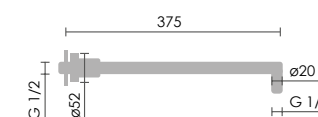

123207RC

Brazo de ducha de 1/2

PVP: 36,00 €



BRAZOS DE DUCHA

123209

Brazo de ducha techo
PVP: 18,00 €



123209RC

Brazo de ducha techo
PVP: 23,00 €



123209NG

Brazo de ducha techo
PVP: 22,00 €



123209OR

Brazo de ducha techo
PVP: 23,00 €



123209GM

Brazo de ducha techo
PVP: 23,00 €



123210

Brazo de ducha techo 17cm
PVP: 24,00 €



123210NG

Brazo de ducha techo 17cm
PVP: 30,00 €

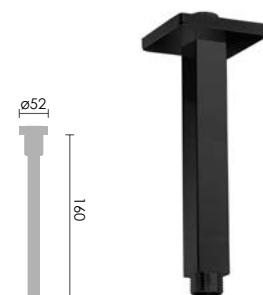

CODOS DE DUCHA

123211

Codo de ducha 1/2 redondo
PVP: 15,00 €

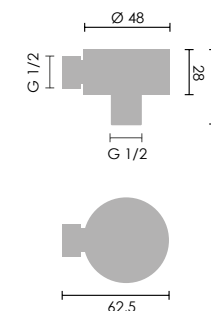

123212

Codo de ducha 1/2 cuadrado
PVP: 17,00 €

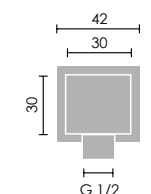

123213

Codo de ducha 1/2 con soporte, redondo
PVP: 27,00 €

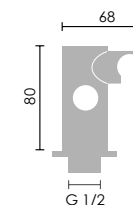

123214

Codo de ducha 1/2 con soporte, cuadrado
PVP: 30,00 €

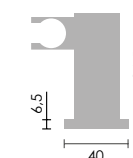

CODOS DE DUCHA



123213OR

Codo de ducha 1/2 con soporte, redondo
PVP: 36,00 €

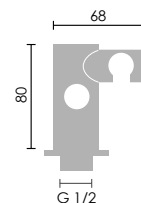

123213RC

Codo de ducha 1/2 con soporte, redondo
PVP: 36,00 €

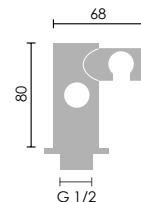

123213NG

Codo de ducha 1/2 con soporte, redondo
PVP: 36,00 €

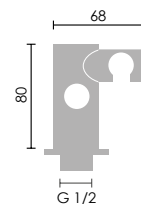

123214NG

Codo de ducha 1/2 con soporte, cuadrado
PVP: 40,00 €

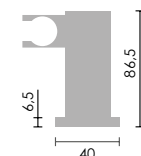

SIFONES

123501

Sifón telescópico de lavabo cuadrado

1 1/4 latón
Cromo

PVP: 44,00 €

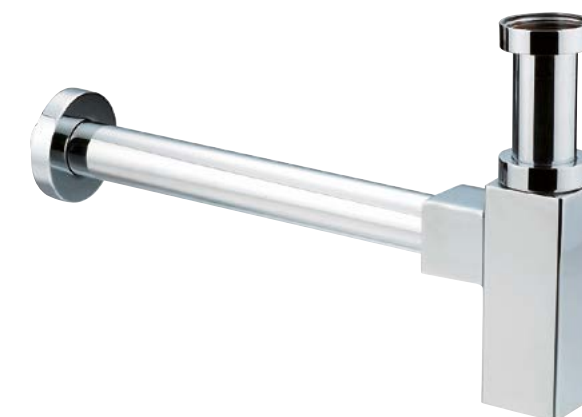

123502

Sifón telescópico de lavabo minimalista

1 1/4 latón
Cromo

PVP: 29,00 €



123503

Sifón Botella

1 1/4 latón
Cromo

PVP: 16,00 €



123512

Tubo Sifón c/pestaña

45 cm.
Cromo

PVP: 15,00 €

123511

Sifón telescópico negro mate

1 1/4 latón
Zamak

PVP: 34,00 €



123511

Sifón telescópico gris metal

1 1/4 latón

PVP: 44,00 €



123514

Sifón telescópico inox.

1 1/4 latón
Zamak

PVP: 38,00 €



123514

Sifón telescópico rosa

1 1/4 latón

PVP: 44,00 €



123515

Sifón telescópico oro cepillado

1 1/4 latón
Zamak

PVP: 42,00 €



Tubo Sifón c/pestaña

45 cm.

- 123512** PVP: 17,00 €
- 123512OR** PVP: 20,00 €
- 123512RC** PVP: 20,00 €
- 123512GM** PVP: 20,00 €
- 123512NG** PVP: 20,00 €

BARRAS DESLIZANTES



122008

Conjunto 510

Ducha 5 posiciones
 Barra ϕ 25 mm
 Longitud 70 cm
 Flexo acero inoxidable 1,70 m
 Doble grapado
 Permite aprovechar los agujeros existentes en la pared

PVP: 31,00 €



122030

Conjunto 310

Ducha 1 posición
 Barra ϕ 22 mm
 Longitud 60 cm
 Flexo acero inoxidable 1,70 m
 Doble grapado

PVP: 30,00 €



122009

Barra deslizante Vip

Barra ϕ 25 mm
 Longitud 70 cm
 Permite aprovechar los agujeros existentes en la pared

PVP: 18,50 €



122040

Barra deslizante

Barra ϕ 20 mm
 Longitud 70 cm
 Fabricada íntegramente en latón
 Permite aprovechar los agujeros existentes en la pared

PVP: 70,00 €

MANGOS DE DUCHA

123015

Ducha 500

5 posiciones
Anticalcárea
Cromo
ø 111 mm

PVP: 9,50 €



123026

Ducha 150

1 posición
Anticalcárea
ø 74,5 mm

PVP: 7,40 €



123009

Ducha 300

3 posiciones
Anticalcárea
Cromo
ø 95 mm

PVP: 7,90 €



123025

Ducha 140

1 posición
Anticalcárea
Cromo
53 mm

PVP: 7,00 €



123001

Ducha 100

1 posición
Anticalcárea
Cromo
ø 96,5 mm

PVP: 6,80 €



123006

Ducha minimalista

1 posición
Anticalcárea
Cromo

PVP: 6,50 €

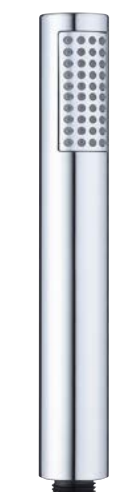

MANGOS DE DUCHA

123007

Ducha extraíble

2 posiciones
Anticalcárea
Cromo
ø 57 mm

PVP: 8,80 €



123014

Ducha 400

4 posiciones
Autolimpiable
Cromo
ø 86 mm

PVP: 8,70 €



123002

Ducha 110

1 posición
Anticalcárea
Cromo
ø 77,6 mm

PVP: 4,90 €



123017

Ducha 310

3 posiciones
Cromo-Blanco
ø 150 mm

PVP: 9,20 €



123005

Ducha 111

1 posición
Anticalcárea
Cromo
ø 68,7 mm

PVP: 4,00 €



123019

Ducha 340

5 posiciones
Anticalcárea
Blanco

PVP: 13,00 €



MANGOS DE DUCHA

123013

Ducha 120

1 posición
Negro mate

PVP: 10,40 €



123010

Ducha 320

5 posiciones
Negro mate
ø 100 mm

PVP: 13,00 €



123020RC

Ducha 360

5 posiciones
Negro mate
ø 100 mm

PVP: 16,00 €



123018

Ducha 330

5 posiciones
Oro
ø 100 mm

PVP: 16,00 €



123022GM

Ducha 350

5 posiciones
Oro
ø 100 mm

PVP: 17,00 €



SOPORTES

123101

Soporte giratorio cónico

Acabado cromo

PVP: 2,70 €



123102

Soporte cónico minimalista

Acabado cromo

PVP: 3,50 €



123103

Soporte cuadrado cónico

Acabado cromo

PVP: 3,80 €



FLEXOS



123104
Flexo extensible cónico
 De 1,50 - 2,00 m
 Doble grapado
 PVP: 6,20 €



123107
Flexo extensible cónico
 1,75 - 2,25 m
 Doble grapado
 PVP: 6,90 €



123108
Flexo cónico
 1,50 m
 Para grifo extraíble
 PVP: 8,90 €



123114
Flexo PVC gris
 1,50 m
 PVP: 11,00 €



123105
Flexo cónico reforzado
 1,70 m
 Doble grapado
 PVP: 5,70 €



123117
Flexo para bidet / inodoro
 1,20 m
 Flexo cónico reforzado antitorsión
 PVP: 7,50 €



123116
Flexo cónico
 1,50 m
 Para grifo extraíble
 Rosca 3/8
 PVP: 8,90 €



123119
Flexo metálico blanco
 1,50 m
 PVP: 11,00 €



123109
Flexo acero inoxidable
 0,60 m
 Doble tuerca hexagonal
 PVP: 4,80 €



123115
Flexo PVC negro mate
 1,50 m
 PVP: 11,00 €



123106
Flexo para bidet / inodoro
 1,20 m
 Flexo PVC negro mate
 PVP: 11,00 €



123112
Flexo cónico bronce
 1,70 m
 PVP: 16,00 €



123118
Flexo cónico oro
 1,70 m
 PVP: 17,00 €



123120
Flexo cónico oro
 1,20 m
 PVP: 14,00 €

VÁLVULAS CLIC-CLAC

123401

Válvula clic-clac N.1

Con rebosadero

PVP: 13,60 €

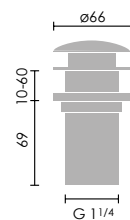

123403

Válvula clic-clac N.3

Con rebosadero. Alto 60

PVP: 13,90 €

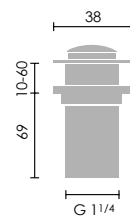

123404

Válvula clic-clac universal

Cromo

PVP: 13,90 €

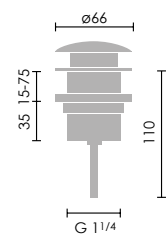

123413

Válvula clic-clac universal tapón pequeño

Con rebosadero

PVP: 13,00 €

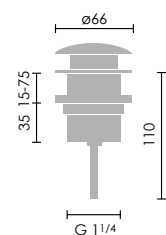

123402

Válvula clic-clac N.2 bronce

Con rebosadero

PVP: 18,50 €

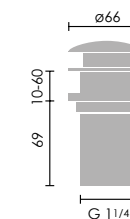

123421

Válvula clic-clac tapón de porcelana

Blanco

PVP: 18,500 €

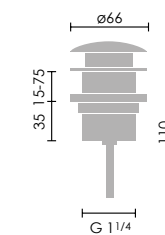

123404GM

Válvula clic-clac universal

Gris Metal

PVP: 22,00 €

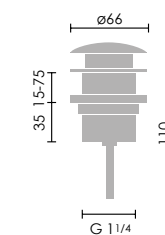

123404NG

Negro mate

PVP: 17,00 €

123404BL

Blanco

PVP: 17,00 €

123404Rc

Rosa cepillado

PVP: 21,00 €

123404OR

Oro cepillado

PVP: 21,00 €

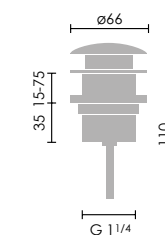

REPUESTOS

■ BARRAS DE DUCHA	347
■ SOPORTE DESLIZANTE	347
■ PLAFONES Y EXCÉNTRICAS	348
■ CARTUCHOS Y MONTURAS	348
■ DISTRIBUIDORES	349
■ DUCHAS BIDÉ / INODORO	349
■ MANETAS	350
■ VOLANTES	350
■ MANETA MEDICA	350
■ AIREADORES	351

BARRAS DE DUCHA

Barra de ducha de 130 cm

121901	Cromo	PVP: 70,00 €
121901NG	Negro	PVP: 94,00 €
121901BL	Blanco	PVP: 84,00 €
121901OR	Oro	PVP: 94,00 €
121901RC	Rosa	PVP: 94,00 €
121901OGM	Gris	PVP: 94,00 €

Barra de ducha de 155 cm

121902	Cromo	PVP: 90,00 €
121902NG	Negro	PVP: 120,00 €
121902OR	Oro	PVP: 120,00 €



SOPORTE DESLIZANTE

Redondo

123100	Cromo	PVP: 7,00 €
123100NG	Negro	PVP: 8,00 €
123100BL	Blanco	PVP: 8,00 €
123100OR	Oro	PVP: 9,00 €

Cuadrado

123111	Cromo	PVP: 7,00 €
123111NG	Negro	PVP: 8,00 €



PLAFONES Y EXCÉNTRICAS

Juego completo

20301	Cuadrado	PVP: 11,00 €
20302	Redondo	PVP: 9,00 €
123306	Estándar	PVP: 6,00 €
123307	Gigante	PVP: 14,00 €



CARTUCHOS Y MONTURAS

20201	25 mm	PVP: 9,00 €
20202	35 mm S.D.	PVP: 10,00 €
20203	35 mm S.L.	PVP: 10,00 €
20204	40 mm S.D.	PVP: 10,00 €
20205	40 mm S.L.	PVP: 10,00 €
20206	35 mm S.L.	PVP: 10,00 € Apertura en frío lavabo.
20207	35 mm S.L.	PVP: 10,00 € Apertura en frío fregadero



20105	Cerámica 1/4 vuelta	PVP: 9,00 €
20106	Osmosis	PVP: 10,00 €
20107	Medical M-5C Cerámica	PVP: 10,00 €
20108	Temporizado	PVP: 10,00 €
20109	Andros	PVP: 45,00 €
20110	Índico	PVP: 45,00 €
20111	Ártico	PVP: 45,00 €



DISTRIBUIDORES

20207 M3/4 - M1/2 - H3/4 PVP: 14,00 €
Olympic / Titanic



20209 M3/4 - M1/2 - H3/4 PVP: 16,00 €



DUCHAS BIDÉ/INODORO

Pistola ABS

121125 Cromo PVP: 6,00 €



Pistola Redonda LATÓN

121126 Cromo PVP: 20,00 €

121126NG Negro PVP: 24,00 €

121126OR Oro PVP: 24,00 €

121126RC Rosa PVP: 24,00 €

121126GM Gris PVP: 24,00 €



Pistola Cuadrada

121118 Cromo PVP: 19,00 €

121118NG Negro PVP: 21,00 €

MANETAS

20015	CÍES	PVP: 10,00 €
20001	KU	PVP: 11,00 €
20001NG	KU NEGRO	PVP: 12,00 €
20005	VARTA	PVP: 10,00 €
20013	YDRA	PVP: 10,00 €
20012	KÍOS	PVP: 10,00 €
20002	BONN	PVP: 8,00 €
20003	KOBA	PVP: 8,00 €
20003NG	KOBA NEGRO	PVP: 9,00 €
20004	JADE	PVP: 8,00 €
20014	ZURICH	PVP: 8,00 €
20006	ALFA	PVP: 7,00 €



VOLANTES

20009	Classic cromo	PVP: 5,80 €
20010	Classic bronce	PVP: 6,70 €



MANETA MEDICAL

20007	1 Agua	PVP: 16,00 €
20008	2 Aguas. Larga	PVP: 10,00 €
20011	2 Aguas. Corta	PVP: 10,00 €



AIREADORES

Cromo

123309	Flexo corto aireador 22 H-24M	PVP: 4,60 €
123301	Aireador hembra 22 mm	PVP: 1,40 €
123301-20	Aireador hembra 20 mm	PVP: 1,50 €
123301-18	Aireador hembra 18 mm	PVP: 1,50 €
123302	Aireador macho 24 mm	PVP: 1,40 €
123302-20	Aireador macho 20 mm	PVP: 1,50 €
123302-18	Aireador macho 18 mm	PVP: 1,50 €
123303	Aireador macho 28 mm	PVP: 2,40 €



Bronce

123301-BR	Aireador hembra 22 mm	PVP: 1,90 €
123302-BR	Aireador macho 22 mm	PVP: 1,90 €



Oro

123301-OR	Aireador hembra 22 mm	PVP: 3,50 €
123302-OR	Aireador macho 24 mm	PVP: 3,50 €
123303-OR	Aireador macho 28 mm	PVP: 6,70 €



CERTIFICADOS

Laboratoire habilité par le Ministère chargé de la santé en application de l'article R*.1321-52 du code de la santé publique

euofins | Expertises Environnementales

ATTESTATION DE CONFORMITE SANITAIRE

Certificate of sanitary conformity

Conformément à l'arrêté du 29 mai 1997 modifié et à la circulaire du Ministère de la Santé
Direction Générale de la Santé DGS/SD7A N° 571 du 25 Novembre 2002

Coordonnées du demandeur d'ACS / Contact details of the ACS owner :

KAIPING KCITEC SANITARY COMPONENTS Co., & Ltd
No. 21-22 Baishitou Area A, Yueshan Town
Kaiping City, Guangdong Province
CHINA, 529300

Nom de l'accessoire représentatif / Reference of the representative accessory :

Cartouche thermostatique TC34 S B ZZZ

N° de dossier attribué par le laboratoire habilité / File reference : **17 ACC NY 143**

Date de réalisation des essais d'inertie selon la norme XP P41-280 / Tests date (according to the standard XP P 41-280) : /

Commentaires / Comments : Aucun essai n'est nécessaire à l'émission de cette ACS / No testing is required to issue this ACS.

Famille d'accessoires couverte par l'ACS / Accessories' family covered by this certificate :

CARTOUCHES THERMOSTATIQUES KCITEC

Références / References : (2 articles et leurs variantes)
TC27 T Y ZZZ
TC34 S Y ZZZ

Y peut se remplacer par B ou W.
ZZZ est le numéro de série de 000 à 999

Attestation délivrée par / Certificate issue by :

Clémence Tafforeau
Chef de Service / Materials Department Manager

Signature : 

Date de délivrance / Date of issue : 18 avril 2017
Date d'expiration / Expiry date : 18 avril 2022

Commentaires / Comments : /

Eurofins Expertises Environnementales
SAS au capital de 71676 € RCS Nancy 751 058 102 TVA FR 35 751 056 102
Siège social : Rue Lucien Cuenot site Saint Jacques II BP 51005 54521 MAXEVILLE cedex - T 03 83 50 36 17 F 03 83 50 23 70

Version : 15.2
Date publication : 19.11.2015

Référence : T-AM-FO26360 1/1



This certifies that

NINGBO WANHAI CARTRIDGE TECHNOLOGY CO. LTD.

has had the undermentioned product(s) examined, tested and certified as being of an appropriate quality and standard as required in the Water Supply (Water Fittings) Regulations and Scottish Water Byelaws, subject to scheme requirements being met when installed.

Model Numbers
 *30D-11: 29.83mm OD.
 35D-1: 34.90mm OD.
 40D-1: 39.84mm OD.
 35H-1: 34.74mm OD.
 40H-1: 40.02mm OD.
 35PH-10B: 34.96mm OD.
 LT35D-11: 34.88mm OD.
 LT35D-13: 35mm OD.
 W25H: 24.9 mm OD.
 35D-1-K: 34.82mm OD.
 40D-1-K: 39.69mm OD.
 35H-1-K: 34.81mm OD.
 40H-1-K: 39.82mm OD.
 W25D-K: 24.90mm OD.
 W25H-K: 24.76mm OD. cartridge headworks *

The certificate by itself is not evidence of a valid WRAS Approval. Confirmation of the current status of an approval must be obtained from the WRAS Approvals Directory (www.wras.co.uk/directory)

The product so mentioned will be valid until the end of:

November 2026

Certificate No.
2111324

Ian Hughes,
WRAS Approvals Manager

CARSO - LABORATOIRE SANTÉ ENVIRONNEMENT HYGIÈNE DE LYON

Laboratoire Agréé pour les analyses d'eaux par le Ministère de la Santé
Laboratoire habilité par le Ministère chargé de la santé en application de l'article R*.1321-52 du code de la santé publique

ATTESTATION DE CONFORMITE SANITAIRE

Certificate of sanitary conformity

Conformément à l'arrêté du 29 mai 1997 modifié et à la circulaire du Ministère de la Santé
Direction Générale de la Santé DGS/SD7A 2002 n°571 du 25 novembre 2002

Coordonnées du demandeur des essais / Contact details of the ACS owner :

NINGBO WANHAI CARTRIDGE TECHNOLOGY CO., LTD.
Xiachen Development Zone,
Chunhu, Fenghua,
Ningbo, Zhejiang
P.R. CHINA

Nom de l'accessoire représentatif / Reference of the representative accessory :

Cartouche céramique / Ceramic cartridge 26H-11

N° de dossier attribué par le laboratoire habilité / File reference : **22 ACC LY 421**

Date de réalisation des essais d'inertie selon la norme XP P41-280 / Aucun essai n'est nécessaire pour délivrer l'ACS
Tests date (according to the standard XP P 41-280) : No testing is required to issue this ACS

Commentaires : Les composants organiques sont conformes à l'arrêté du 29 mai 1997 modifié. Les composants métalliques sont conformes à l'arrêté du 25 juin 2020.
Comments : Organic components are compliant with the decree dated 29th May 1997 modified. Metallic components are compliant with the decree dated 25th June 2020.

Famille d'accessoires couverte par l'ACS / Accessories' family covered by this certificate :

Cartouches céramique / Ceramic cartridges

Références / References (53 references) :

25DK-1	26H-11	35H-2	40D-1FX	40PH
25DK-2	35D-1	35H-10	40D-2	360° 35D-1
25D-QH	35D-1B	35HPK	40D-3	360° 35D-2
35D-1T	35D-1F	35P-1	40D-10	360° 35H-1
35D-2	35D-1FD	35PH-1	40DPK	360° 35H-2
35D-3	35D-1FX	35PH-10	40H-1	360° 40D-1
40D-1T	35D-7	35PH-10B	40H-2	360° 40D-2
25D-1	35D-10	D36-1S	40H-10	360° 40H-1
25D-2	35D-10SP	40D-1	40HSX	360° 40H-2
25DPK	35DPK	40D-1B	40P-1	
26H-10	35H-1W	40D-1F	40PH-1	

Attestation délivrée par : Christelle AUTUGELLE
Responsable Laboratoire MCDE
CARSO - L.S.E.H.L.

Signature : 

A la date du / Date of issue : 15 Juillet 2022
Date d'expiration / Expiration date : 15 Juillet 2027

Commentaires / Comments : renouvellement / renewal 17 ACC LY 448

E. MC060-P-15/09/2014 M11N
Score de Reconnaissance de Signaler de 2 283 622.38 Euros - RCS Lyon B 410 545 313 - SIRET 410 545 313 00042 - APE 743 B - N° TVA : FR 82 410 545 313
Siège Social et laboratoire : 4, avenue Jean Moulin - CS 30228 - F - 69633 VIENISSEUX cedex - Tél. : (33) 04 72 76 16 16 - Fax : (33) 04 78 72 35 03
Site web : www.groupecarso.com - e-mail : mcde@groupecarso.com

Condiciones generales de venta

1. Los precios incluidos en el presente catálogo tarifa son precios de venta al público.
2. A los precios indicados se les incrementará el IVA correspondiente.
3. CLAUS Y BATH, S.L. se reserva el dominio de las mercancías suministradas hasta el cobro integro de las mismas.
4. CLAUS Y BATH, S.L. no admitirá ninguna devolución por roturas en transporte transcurridas 24 horas de la recepción de la misma y siendo indispensable haber indicado en el talón de entrega de la agencia, la frase PENDIENTE DE REVISAR, EMBALAJE DAÑADO, o cualquier otra similar que nos permita efectuar la reclamación al seguro del transporte, teniendo un plazo de 1 DÍA HÁBIL para poder efectuar dicha reclamación.
5. Las devoluciones de mercancía siempre se realizarán por el medio de transporte que CLAUS Y BATH, S.L. designe y este será el encargado de dar la orden de recogida.
6. Sólo se consideran válidos los PAGOS efectuados directamente a CLAUS Y BATH, S.L., o a la persona que la represente, en cuyo caso siempre serán nominativos a CLAUS Y BATH, S.L.
7. Todos los productos de CLAUS Y BATH, S.L. tienen una GARANTÍA de dos años contra cualquier defecto de fabricación.
8. No se incluyen en la garantía los desperfectos causados por golpes, uso de productos químicos o abrasivos, por manipulación o instalación incorrecta, o los causados por impurezas del agua, etc.
9. No se repondrá ninguna grifería completa cuando la pieza defectuosa pueda ser sustituida.
10. Los clientes al realizar cualquier pedido, que deberán ser por correo electrónico o fax, aceptan todas las condiciones generales de venta reflejadas en este catálogo tarifa.
11. CLAUS Y BATH, S.L. se reserva el derecho de modificar, sin previo aviso, precios y condiciones generales de venta, así como características técnicas, componentes o medidas de los productos reflejados en este dossier, ya sean por razones técnicas o comerciales.
12. Los portes en Península serán pagados a partir de 150 euros. Para pedidos inferiores se cargarán 5 euros en factura.
13. En caso de producirse litigio, serán competentes los Tribunales de Valencia, con renuncia expresa a cualquier otro fuero.
14. Esta tarifa de precios anula todas las anteriores.



Platos Ducha S.L.
C/ Pobla de Farnal, 29
46021 Valencia - España
Mvl. 657 290 619
wictordla@hotmail.com